

GENERAL INFORMATION

STEEL DROPIN™

Internally Threaded Expansion Anchor

PRODUCT DESCRIPTION

The Steel Dropin is an all-steel, machine bolt anchor available in carbon steel and two types of stainless steel. It can be used in solid concrete, including lightweight concrete and concrete-filled steel deck members. The anchors can also be considered for hard stone and solid block base materials. A coil thread version for forming applications is also available.

GENERAL APPLICATIONS AND USES

- Suspending Conduit
- Fire Sprinkler Supports
- Cable Trays and Strut
- Concrete Formwork
- Pipe Supports
- Suspended Lighting

FEATURES AND BENEFITS

- + Internally threaded anchor for easy bolt removability and service work
- + Flanged (lipped) version installs flush for easy inspection and standard embedment
- + Smooth wall dropin can be installed flush mounted or below the base material surface (optionally available with a knurled body)
- + Coil thread version accepts coil rod and typically used for concrete formwork applications

TESTING, APPROVALS AND LISTINGS

- Tested in accordance with ASTM E488 in uncracked concrete
- Underwriters Laboratory (UL Listed) – File No. EX1289 and VFXT7.EX1289, see listing for sizes
- FM Approvals (Factory Mutual) – see approval for sizes
- Federal GSA Specification – meets descriptive characteristics of CID A-A-55614 (formerly FF-S-325, Group VIII, Type 1)

GUIDE SPECIFICATIONS

CSI Divisions: 03 16 00 - Concrete Anchors and 05 05 19 - Post-Installed Concrete Anchors. Dropin anchors shall be Steel Dropin as supplied by DEWALT, Towson, MD. Anchors shall be installed in accordance with published instructions and the Authority Having Jurisdiction.

SECTION CONTENTS

General Information..... 1
 Material Specifications 2
 Installation Specifications 2
 Performance Data (ASD) 3
 Ordering Information..... 6



SMOOTH WALL DROPIN

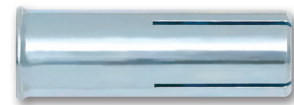

FLANGE (LIPPED) DROPIN

THREAD VERSION

- UNC Coarse Thread
- Coil Thread

ANCHOR MATERIALS

- Zinc Plated Carbon Steel
- 303 Stainless Steel (Domestic Version)
- 304 Stainless Steel
- 316 Stainless Steel

ROD/ANCHOR SIZE RANGE (TYP.)

- 1/4" to 3/4" diameter UNC (Coarse Thread)
- 1/2" and 3/4" diameter Coil Thread

SUITABLE BASE MATERIALS

- Normal-weight Concrete
- Lightweight Concrete

MATERIAL SPECIFICATIONS

Anchor Component	Carbon Steel	300 Series Stainless Steel	Type 316 Stainless Steel
Anchor Body	AISI 1008	Type 303/304 Stainless Steel	Type 316 Stainless Steel
Plug	AISI 1018	Type 303/304 Stainless Steel	Type 316 Stainless Steel
Zinc Plating	ASTM B633, SC1, Type III (Fe/Zn 5) Not Applicable		

Stainless steel anchor components are passivated.

INSTALLATION SPECIFICATIONS

Parameter	Rod/Anchor Diameter, d						
	1/4"	3/8"	1/2"	1/2" Coil Thread	5/8"	3/4"	3/4" Coil Thread
ANSI Drill Bit Size, d_{bit} (in.) Nominal Outside Diameter of Anchor, d (in.)	3/8	1/2	5/8	5/8	7/8	1	1
Maximum Tightening Torque, T_{max} (ft.-lbs.)	5	10	20	20	40	80	80
Internal Thread Size (UNC)	1/4"-20	3/8"-16	1/2"-13	1/2"-6	5/8"-11	3/4"-10	3/4"- 4½
Thread Depth (in.)	7/16	5/8	13/16	13/16	1-3/16	1-3/8	1-3/8
Flange Size, Lipped Version (in.)	7/16	9/16	45/64	—	—	—	—
Min. concrete thickness, h (in.)	3	3	3-1/2	3-1/2	4-1/2	5-1/2	5-1/2
Anchor Length, l (in.) Embedment, h_v (in.) Hole depth, h_o (in.)	1	1-9/16	2	2	2-1/2	3-3/16	3-3/16

Installation Procedure

Using the proper drill bit size, drill a hole into the base material to the depth of embedment required. The tolerances of the drill bit used must meet the requirements of ANSI Standard B212.15. Do not over drill the hole unless the application calls for a subset anchor.

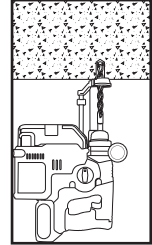

Remove dust and debris from the hole during drilling (e.g. dust extractor, hollow bit) or following drilling (e.g. suction, forced air) to extract loose particles created by drilling. Insert the anchor into the hole and tap flush with surface.

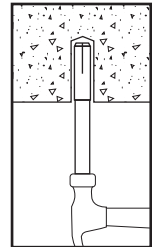

Using a DEWALT setting tool specifically, set the anchor by driving the tool with a sufficient number of hammer blows until the shoulder of the tool is seated against the anchor. Note: anchor will not hold published load if shoulder of DEWALT setting tool does not seat against anchor.

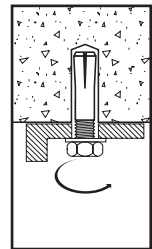

If using a fixture, position it, insert bolt and tighten. Most overhead applications typically utilize threaded rod. Minimum thread engagement should be at least one anchor diameter.

Nomenclature

- d = Diameter of anchor
- d_{bit} = Diameter of drill bit
- h = Min. base material thickness
- h_v = Minimum embedment depth
- l = Overall length of anchor
- T_{max} = Maximum tightening torque

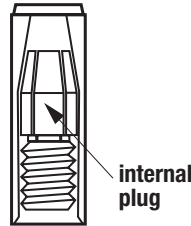
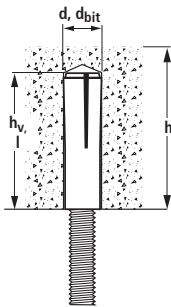

internal plug

PERFORMANCE DATA (ASD)

Ultimate and Allowable Load Capacities for Steel Dropin in Normal-Weight Concrete^{1,2,3,4,5}

Rod/Anchor Diameter d in.	Minimum Embedment Depth in. (mm)	Tension						Shear	
		2,000 psi (13.8 MPa)		4,000 psi (27.6 MPa)		6,000 psi (41.4 MPa)		f'c ≥ 2000 psi (13.8 MPa)	
		Ultimate lbs. (kN)	Allowable lbs. (kN)	Ultimate lbs. (kN)	Allowable lbs. (kN)	Ultimate lbs. (kN)	Allowable lbs. (kN)	Ultimate lbs. (kN)	Allowable lbs. (kN)
1/4	1 (25)	1,140 (5.1)	285 (1.3)	1,985 (8.9)	495 (2.2)	2,080 (9.4)	520 (2.3)	2,120 (9.5)	530 (2.4)
3/8	1-9/16 (40)	2,180 (9.8)	545 (2.5)	4,180 (18.8)	1,045 (4.7)	4,950 (22.3)	1,240 (5.6)	4,585 (20.6)	1,145 (5.2)
1/2	2 (51)	4,105 (18.5)	1,025 (4.6)	5,760 (25.9)	1,440 (6.5)	6,585 (29.6)	1,645 (7.4)	6,400 (28.8)	1,600 (7.2)
5/8	2-1/2 (64)	4,665 (21.0)	1,165 (5.2)	7,440 (33.5)	1,860 (8.4)	10,400 (46.3)	2,600 (11.6)	12,380 (55.7)	3,095 (13.9)
3/4	3-3/16 (81)	8,580 (38.6)	2,145 (9.7)	9,405 (41.8)	2,350 (10.5)	11,300 (50.3)	2,825 (12.6)	15,680 (70.6)	3,920 (17.6)

1. Tabulated load values are applicable to carbon and stainless steel anchors.
2. Tabulated load values are for anchors installed in uncracked concrete. Concrete compressive strength must be at the specified minimum at the time of installation.
3. Ultimate load capacities must be reduced by a minimum safety factor of 4.0 or greater to determine allowable working load.
4. Allowable load capacities for 3000 psi concrete may be calculated by reducing the tabulated allowable load values in 4000 psi concrete by 9 percent. Allowable load capacities for 5000 psi concrete may be calculated by reducing the tabulated allowable load values in 6000 psi concrete by 6 percent.
5. The tabulated capacities are for the steel dropin anchors which must be checked against the steel strength of the corresponding threaded rod or bolt size and type, the lowest load level controls.

Ultimate and Allowable Load Capacities for Steel Dropin in Lightweight Concrete^{1,2,3,4,5,6}

Rod/Anchor Diameter d in.	Minimum Embedment Depth in. (mm)	Tension						Shear	
		2,000 psi (13.8 MPa)		4,000 psi (27.6 MPa)		6,000 psi (41.4 MPa)		f'c ≥ 2000 psi (13.8 MPa)	
		Ultimate lbs. (kN)	Allowable lbs. (kN)	Ultimate lbs. (kN)	Allowable lbs. (kN)	Ultimate lbs. (kN)	Allowable lbs. (kN)	Ultimate lbs. (kN)	Allowable lbs. (kN)
1/4	1 (25)	1,060 (4.8)	265 (1.2)	1,360 (6.1)	340 (1.5)	1,660 (7.5)	415 (1.9)	1,920 (8.6)	480 (2.2)
3/8	1-9/16 (40)	2,040 (9.1)	510 (2.3)	3,780 (17.0)	945 (4.3)	4,520 (20.3)	1,130 (5.1)	4,120 (18.5)	1,030 (4.6)
1/2	2 (51)	3,840 (17.1)	960 (4.3)	4,840 (21.8)	1,210 (5.4)	5,460 (24.6)	1,365 (6.1)	5,680 (25.6)	1,420 (6.4)
5/8	2-1/2 (64)	4,200 (18.7)	1,050 (4.7)	6,325 (28.1)	1,580 (7.0)	8,840 (39.8)	2,210 (9.9)	8,135 (36.5)	2,050 (9.1)
3/4	3-3/16 (81)	7,295 (32.5)	1,825 (8.1)	7,995 (35.6)	2,000 (8.9)	9,605 (42.7)	2,400 (10.7)	13,330 (59.3)	3,335 (14.8)

1. Tabulated load values are applicable to carbon and stainless steel anchors.
2. Tabulated load values are for anchors installed in uncracked concrete. Concrete compressive strength must be at the specified minimum at the time of installation.
3. Ultimate load capacities must be reduced by a minimum safety factor of 4.0 or greater to determine allowable working load.
4. Allowable load capacities for 3000 psi concrete may be calculated by reducing the tabulated allowable load values in 4000 psi concrete by 9 percent. Allowable load capacities for 5000 psi concrete may be calculated by reducing the tabulated allowable load values in 6000 psi concrete by 6 percent.
5. Allowable load capacities are multiplied by reduction factors found in the Design Criteria section when anchor spacing or edge distances are less than critical distances.
6. The tabulated capacities are for the steel dropin anchors which must be checked against the steel strength of the corresponding threaded rod or bolt size and type, the lowest load level controls.

UL Listings and FM Approvals for Supporting Fire Protection Services & Automatic Sprinkler Systems^{1,2}

Listing/Approval	Steel Dropin, Smooth Wall					Steel Dropin, Flanged (Lipped) and Knurled Wall		
	1/4"	3/8"	1/2"	5/8"	3/4"	1/4"	3/8"	1/2"
UL Max. Pipe Size	N/A	4"	8"	12"	12"	N/A	4"	8"
FM Max. Pipe Size	N/A	4"	8"	12"	12"	N/A	-	-

Underwriters Laboratories (UL Listed) – File No. EX1289 and VFXT7.EX1289

FM Approvals (Factory Mutual)

1. Stainless steel smooth wall dropins are not part of the FM approval at the time of publication.
2. Domestic dropins are not part of the UL listing or FM approval at the time of publication.

Ultimate and Allowable Load Capacities for Steel Dropin in Lightweight Concrete over Steel Deck^{1,2,3,4,5,6,7}

Rod/Anchor Diameter d in.	Minimum Embedment Depth h in. (mm)	Lightweight Concrete over Steel Deck, f'c ≥ 3,000 (20.7 MPa)							
		Minimum 4-1/2" Wide Deck				Minimum 1-1/2" Wide Deck			
		Ultimate Load		Allowable Load		Ultimate Load		Allowable Load	
		Tension lbs. (kN)	Shear lbs. (kN)	Tension lbs. (kN)	Shear lbs. (kN)	Tension lbs. (kN)	Shear lbs. (kN)	Tension lbs. (kN)	Shear lbs. (kN)
1/4	1 (25)	760 (3.4)	2,040 (9.2)	190 (0.8)	510 (2.3)	400 (1.8)	2,040 (9.2)	100 (0.4)	510 (2.3)
3/8	1-9/16 (40)	960 (4.3)	2,760 (12.3)	240 (1.1)	690 (3.1)	600 (2.7)	2,760 (12.3)	150 (0.7)	690 (3.1)
1/2	2 (51)	2,740 (12.3)	5,560 (25.0)	685 (3.1)	1,390 (6.3)	-	-	-	-

1. Tabulated load values are for carbon steel and stainless steel anchors installed in uncracked sand-lightweight concrete over steel deck. Concrete compressive strength must be at the specified minimum at the time of installation.
2. Allowable load capacities listed are calculated using and applied safety factor of 4.0.
3. Allowable load capacities are multiplied by reduction factors found in the Design Criteria section when anchor spacing distances are less than critical distances.
4. For tabulated load capacities in 4-1/2" wide deck flute, the minimum lower flute edge distance is 1-1/4". Tabulated load capacities in 1-1/2" wide deck flute are for anchors installed in the center of the lower flute.
5. For installations into the lower flute the minimum topping thickness is 2 inches. For installations into the upper flute, the minimum topping thickness is 3" for 1/4-inch and 3/8-inch diameter anchors; and 3-1/2" for 1/2-inch diameter anchors. Allowable shear loads for anchors installed through steel deck into concrete may be applied in any direction.
6. Anchors can be considered for use in the lower or upper flute of the steel deck provided the installation specifications and procedures are maintained.
7. The tabulated capacities are for the steel dropin anchors which must be checked against the steel strength of the corresponding threaded rod or bolt size and type, the lowest load level controls.

SAND-LIGHTWEIGHT CONCRETE OR NORMAL WEIGHT CONCRETE OVER STEEL DECK (MINIMUM 3,000 PSI)

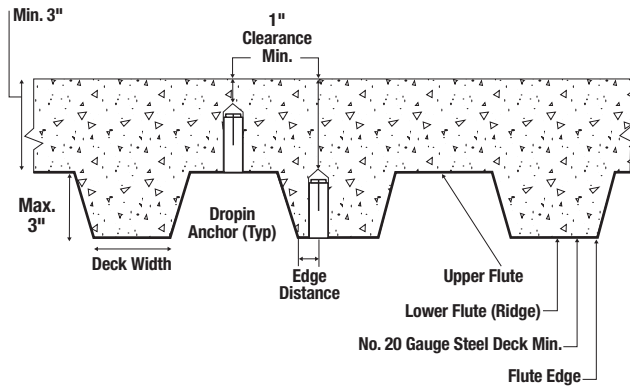

Combined Loading

For anchors loaded in both shear and tension, the combination of loads should be proportioned as follows:

$$\left(\frac{N_u}{N_n}\right) + \left(\frac{V_u}{V_n}\right) \leq 1$$

Where: N_u = Applied Service Tension Load
 N_n = Allowable Tension Load
 V_u = Applied Service Shear Load
 V_n = Allowable Shear Load

Load Adjustment Factors for Spacing and Edge Distances¹

Anchor Installed in Normal-Weight Concrete

Anchor Dimension	Load Type	Critical Distance (Full Anchor Capacity)	Critical Load Factor	Minimum Distance (Reduced Capacity)	Minimum Load Factor
Spacing (s)	Tension and Shear	$S_{cr} = 3.0h_v$	$F_{NS} = F_{VS} = 1.0$	$S_{min} = 1.5h_v$	$F_{NS} = F_{VS} = 0.50$
Edge Distance (c)	Tension	$C_{cr} = 14d$	$F_{NC} = 1.0$	$C_{min} = 7d$	$F_{NC} = 0.90$
	Shear	$C_{cr} = 14d$	$F_{VC} = 1.0$	$C_{min} = 7d$	$F_{VC} = 0.50$

Anchor Installed in Lightweight Concrete

Anchor Dimension	Load Type	Critical Distance (Full Anchor Capacity)	Critical Load Factor	Minimum Distance (Reduced Capacity)	Minimum Load Factor
Spacing (s)	Tension and Shear	$S_{cr} = 3.0h_v$	$F_{NS} = F_{VS} = 1.0$	$S_{min} = 1.5h_v$	$F_{NS} = F_{VS} = 0.50$
Edge Distance (c)	Tension	$C_{cr} = 14d$	$F_{NC} = 1.0$	$C_{min} = 7d$	$F_{NC} = 0.80$
	Shear	$C_{cr} = 14d$	$F_{VC} = 1.0$	$C_{min} = 7d$	$F_{VC} = 0.50$

1. Allowable load values found in the performance data tables are multiplied by reduction factors when anchor spacing or edge distances are less than critical distances. Linear interpolation is allowed for intermediate anchor spacing and edge distances between critical and minimum distances. When an anchor is affected by both reduced spacing and edge distance, the spacing and edge reduction factors must be combined (multiplied). Multiple reduction factors for anchor spacing and edge distance may be required depending on the anchor group configuration.

LOAD ADJUSTMENT FACTORS FOR NORMAL-WEIGHT AND LIGHTWEIGHT CONCRETE

Spacing, Tension (F_{NS}) & Shear (F_{VS})

Dia. (in.)		1/4	3/8	1/2	5/8	3/4
h. (in.)		1	1-1/2	2	2-1/2	3
S _{cr} (in.)		3	4-1/2	6	7-1/2	9
s _{min} (in.)		1-1/2	2-1/4	3	3-3/4	4-1/2
Spacing Distance (inches)	1-1/2	0.50	-	-	-	-
	2-1/4	0.75	0.50	-	-	-
	3	1.00	0.67	0.50	-	-
	3-3/4	1.00	0.83	0.63	0.50	-
	4	1.00	0.89	0.67	0.53	-
	4-1/2	1.00	1.00	0.75	0.60	0.50
	5	1.00	1.00	0.83	0.67	0.56
	6	1.00	1.00	1.00	0.80	0.67
	7-1/2	1.00	1.00	1.00	1.00	0.83
9	1.00	1.00	1.00	1.00	1.00	

Notes: For anchors loaded in tension and shear, the critical spacing (S_{cr}) is equal to 3 embedment depths ($3h$) at which the anchor achieves 100% of load.

Minimum spacing (s_{min}) is equal to 1.5 embedment depths ($1.5h$) at which the anchor achieves 50% of load.

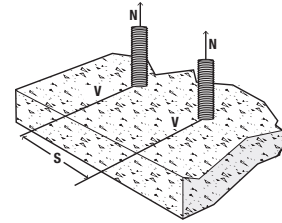

Edge Distance, Tension (F_{NC}) (Normal-Weight concrete only)

Dia. (in.)		1/4	3/8	1/2	5/8	3/4
c _{cr} (in.)		3-1/2	5-1/4	7	8-3/4	10-1/2
c _{min} (in.)		1-3/4	2-5/8	3-1/2	4-3/8	5-1/4
Edge Distance, c (inches)	1-3/4	0.90	-	-	-	-
	2	0.91	-	-	-	-
	2-5/8	0.95	0.90	-	-	-
	3	0.97	0.91	-	-	-
	3-1/2	1.00	0.93	0.90	-	-
	4-3/8	1.00	0.97	0.93	0.90	-
	5-1/4	1.00	1.00	0.95	0.92	0.90
	6	1.00	1.00	0.97	0.94	0.91
	7	1.00	1.00	1.00	0.96	0.93
	8	1.00	1.00	1.00	0.98	0.95
	8-3/4	1.00	1.00	1.00	1.00	0.97
10-1/2	1.00	1.00	1.00	1.00	1.00	

Notes: For anchors loaded in tension, the critical edge (c_{cr}) is equal to 14 anchors diameters ($14d$) at which the anchor achieves 100% of load.

Minimum edge distance (c_{min}) is equal to 7 anchor diameters ($7d$) at which the anchor achieves 90% of load for normal-weight concrete and 80% of load for light-weight concrete.

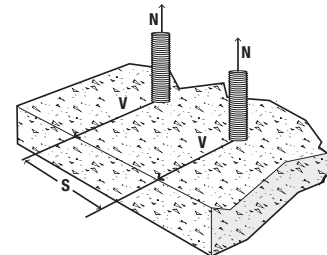

Edge Distance, Tension (F_{NC}) (Lightweight concrete only)

Dia. (in.)		1/4	3/8	1/2	5/8	3/4
c _{cr} (in.)		3-1/2	5-1/4	7	8-3/4	10-1/2
c _{min} (in.)		1-3/4	2-5/8	3-1/2	4-3/8	5-1/4
Edge Distance, c (inches)	1-3/4	0.80	-	-	-	-
	2	0.83	-	-	-	-
	2-5/8	0.90	0.80	-	-	-
	3	0.94	0.83	-	-	-
	3-1/2	1.00	0.87	0.80	-	-
	4-3/8	1.00	0.93	0.85	0.80	-
	5-1/4	1.00	1.00	0.90	0.84	0.80
	6	1.00	1.00	0.94	0.87	0.83
	7	1.00	1.00	1.00	0.92	0.87
	8	1.00	1.00	1.00	0.97	0.90
	8-3/4	1.00	1.00	1.00	1.00	0.93
10-1/2	1.00	1.00	1.00	1.00	1.00	

Edge Distance, Shear (F_{VC})

Dia. (in.)		1/4	3/8	1/2	5/8	3/4
c _{cr} (in.)		3-1/2	5-1/4	7	8-3/4	10-1/2
c _{min} (in.)		1-3/4	2-5/8	3-1/2	4-3/8	5-1/4
Edge Distance, c (inches)	1-3/4	0.50	-	-	-	-
	2	0.57	-	-	-	-
	2-5/8	0.75	0.50	-	-	-
	3	0.86	0.57	-	-	-
	3-1/2	1.00	0.67	0.50	-	-
	4-3/8	1.00	0.83	0.63	0.50	-
	5	1.00	0.95	0.71	0.57	-
	5-1/4	1.00	1.00	0.75	0.60	0.50
	6	1.00	1.00	0.86	0.69	0.57
	7	1.00	1.00	1.00	0.80	0.67
	8	1.00	1.00	1.00	0.91	0.76
	8-3/4	1.00	1.00	1.00	1.00	0.83
	10	1.00	1.00	1.00	1.00	0.95
10-1/2	1.00	1.00	1.00	1.00	1.00	

Notes: For anchors loaded in shear, the critical edge distance (c_{cr}) is equal to 14 anchor diameters ($14d$) at which the anchor achieves 100% of load.

Minimum edge distance (c_{min}) is equal to 7 anchor diameters ($7d$) at which the anchor achieves 50% of load.

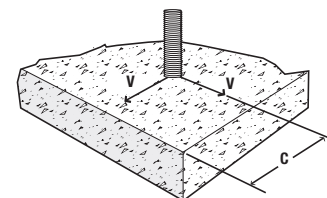

ORDERING INFORMATION

Carbon Steel Smooth Wall Dropin

Cat. No.	Domestic Cat. No.	Rod/Anchor Size	Overall Length	Outside Diameter	Pack Qty.	Carton Qty.
06304-PWR	6304USA-PWR	1/4"	1"	3/8"	100	1000
06306-PWR	6306USA-PWR	3/8"	1-9/16"	1/2"	50	500
06308-PWR	6308USA-PWR	1/2"	2"	5/8"	50	300
06320-PWR	6320USA-PWR	5/8"	2-1/2"	7/8"	25	125
06312-PWR	6312USA-PWR	3/4"	3-3/16"	1"	10	50



Carbon Steel Flanged Dropin (Lipped)

Cat. No.	Rod/Anchor Size	Overall Length	Outside Diameter	Pack Qty.	Carton Qty.
06324-PWR	1/4"	1"	3/8"	100	1,000
06326-PWR	3/8"	1-9/16"	1/2"	50	500
06328-PWR	1/2"	2"	5/8"	50	300



Carbon Steel Knurled Wall Dropin

Cat. No.	Rod/Anchor Size	Overall Length	Outside Diameter	Pack Qty.	Carton Qty.
06340-PWR	1/4"	1"	3/8"	100	1,000
06342-PWR	3/8"	1-9/16"	1/2"	50	500
06344-PWR	1/2"	2"	5/8"	50	250

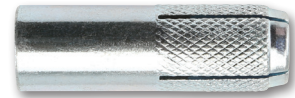

Type 300 Series Stainless Steel Dropin

Cat. No. (Type 304)	Domestic Cat. No. (Type 303)	Rod/Anchor Size	Overall Length	Outside Diameter	Pack Qty.	Carton Qty.
06204-PWR	6204USA-PWR	1/4"	1"	3/8"	100	1000
06206-PWR	6206USA-PWR	3/8"	1-9/16"	1/2"	50	500
06208-PWR	6208USA-PWR	1/2"	2"	5/8"	50	300
06210-PWR	6210USA-PWR	5/8"	2-1/2"	7/8"	25	125
06212-PWR	6212USA-PWR	3/4"	3-3/16"	1"	10	50



Type 316 Stainless Steel Dropin

Cat. No.	Domestic Cat. No.	Rod/Anchor Size	Overall Length	Outside Diameter	Pack Qty.	Carton Qty.
06224-PWR	6224USA-PWR	1/4"	1"	3/8"	100	1000
06226-PWR	6226USA-PWR	3/8"	1-9/16"	1/2"	50	500
06228-PWR	6228USA-PWR	1/2"	2"	5/8"	50	300
06230-PWR	6230USA-PWR	5/8"	2-1/2"	7/8"	25	125
06232-PWR	-	3/4"	3-3/16"	1"	10	50



Carbon Steel Coil Thread Dropin

Cat. No.	Rod/Anchor Size	Overall Length	Outside Diameter	Pack Qty.	Carton Qty.
06330-PWR	1/2"	2"	5/8"	50	300
06332-PWR	3/4"	3-3/16"	1"	10	50



Setting Tools for Steel Dropin

Cat. No.	06305-PWR	06307-PWR	06309-PWR	06311-PWR	06313-PWR
Rod/Anchor Size	1/4"	3/8"	1/2"	5/8"	3/4"
Pin Length	39/64"	61/64"	1-3/16"	1-5/16"	1-61/64"
Pack Qty.	1	1	1	1	1



Accu-Bit™ Drill Stop for Steel Dropin

Cat. No.	Rod/Anchor Size	Drill Stop	Pack Qty.
DWA5493	1/2" Accu-Bit for 3/8" Steel Dropin	1-13/16"	1
DWA5495	5/8" Accu-Bit for 1/2" Steel Dropin	2-3/8"	1

