

DEWALT®



Instruction Manual Guide D'utilisation Manual De Instrucciones



CCU+™ Critical Connection Undercut Anchoring System

The DEWALT Critical Connection Undercut (CCU+™) Anchoring system is a specified anchor system incorporating an undercut anchor and various installation accessories and specific power tools. The contents of this manual will help guide the installer through proper preparation, installation, maintenance and troubleshooting of the CCU+™ anchoring system.

This manual is not a substitute for construction drawings or specifications. CCU+™ anchors may be part of an engineered structure. Proper anchor placement and installation are critical to the performance of the structure.

The installer should make sure they have the correct anchors, bits, hammers, vacs and accessories to install CCU+™ anchors as per any construction drawings.



www.DEWALT.com

If you have questions or comments, contact us.
Pour toute question ou tout commentaire, nous contacter.
Si tiene dudas o comentarios, contáctenos.

1-800-4-DEWALT

TABLE OF CONTENT

1. The Critical Connection Undercut System (CCU+™)

- A. Anchor
- B. Primary bit
- C. Undercut bit
- D. Setting tool

2. Compliance

- A. ICC-ES
- B. OSHA
- C. MIUSA

3. Specification of the anchor

- A. Material
- B. Installation parameters

4. Installation

- A. Power tools and accessories
- B. Installation instructions

5. Replacing wear parts

- A. Bow jaw
- B. Cutter blade
- C. Instructions

6. Trouble shooting

- A. Cleaning of primary hollow bit
- B. Un-jamming of undercut bit



1. THE CRITICAL CONNECTION UNDERCUT SYSTEM (CCU+™)

A. Anchor



B. Primary bit



HSDB: Hollow stop drill bit for specific drilling depth, primarily used for drilling until collar touches the concrete surface in case of preset installation



HDB: Hollow drill bit for variable drilling depth, primarily used for drilling through the fixture in case of thru-bolt installation

C. Undercut bit



HUCB: Hollow undercut bit for dust-free undercutting

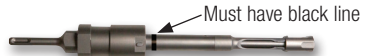

UCB: Undercut bit for economic undercutting

D. Setting tool



Setting tool for power tool installation with SDS connector



Setting tool for manual installation with hand held hammer

2. COMPLIANCE

A. ICC-ES

Steel grades A36 and A193, Gr. B7 and SS316 qualified according to ACI 355.2 for design according to ACI 318: ESR-4810
Download Anchor Design Software DDA™ at:
DEWALT.COM/DDA



B. OSHA

Part of an OSHA Table 1 compliant system.
Dust Extractor System with HEPA Filtration and /Auto Cleaning
Hollow Bit System: HDB, HSDB, HUCB (see above)
Use hood, shroud, etc. to control dust when using conventional bits.



C. Anchors Made In The USA*

We can certify CCU+™ anchors for Trade Agreements Act (TAA), Buy American Act (BAA), American Iron and Steel (AIS), Build America, Buy America Act (BABA), and Buy America (FHWA, FAA, FRA, FTA).

Please email anchors@dewalt.com for certification information.



*As of the date of this Instruction Manual, DeWALT Critical Connection Undercut Anchors meet the requirements of the Trade Agreements Act (TAA), Buy American Act (BAA), American Iron and Steel (AIS), Build America, Buy America Act (BABA), and Buy America (FHWA, FAA, FRA, FTA).

3. SPECIFICATION OF THE ANCHOR

A. Material

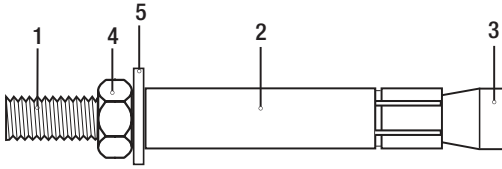

- 1 - Rod
- 2 - Sleeve
- 3 - Cone
- 4 - Nut
- 5 - Washer

Component No.	Description	Specifications	
		Carbon Steel Version (A36 or B7)	High Strength Stainless Steel (316 SS)
1	Rod	ASTM A36 or ASTM A193 Grade B7, Zinc Plated ASTM B633, SC1 (Fe/Zn 5)	ASTM A193, Grade 8BM, Class 2 (316 SS)
2	Sleeve	Carbon Steel, Zinc Plated ASTM B633, SC1 (Fe/Zn 5)	AISI 316 SS
3	Cone	Carbon Steel, Zinc Plated ASTM B633, SC1 (Fe/Zn 5)	AISI 316 SS
4	Nut	3/8" DIA A36: SAE J955 Grade 2 3/8" DIA B7: SAE J955 Grade 8 1/2", 5/8", 3/4" DIA: ASTM A563, Grade C	3/8" DIA SS2: ASTM F594 SS 316 Alloy Group 2 1/2", 5/8", 3/4" DIA: ASTM A194, Grade 8M (316 SS)
5	Washer	ASTM F844; Meets ANSI/ASME B18.22.1, Type A plain (wide)	AISI 316 SS; meets ANSI/ASME B18.22.1, Type A plain (wide)

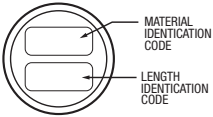

Material Identification Code	A36	B7	SS2
Length Identification Code	Refer to Installation Parameter Section		

Head of Anchor Rod

Anchor Size	Symbol	Unit	3/8"	1/2"	5/8"	3/4"
Nominal anchor diameter [equals rod diameter]	d_a	in. (mm)	3/8 = 0.375 (9.5)	1/2 = 0.5 (12.7)	5/8 = 0.625 (15.9)	3/4 = 0.75 (19.1)
Outside anchor diameter [equals drill bit diameter]	$d_{nom} = d_{bit}$	in. (mm)	11/16 = 0.688 (17.5)	13/16 = 0.813 (20.6)	1 = 1.000 (25.4)	1-1/4 = 1.250 (31.8)
Nominal embedment depth [equals drill hole depth]	h_{nom}	in. (mm)	4-1/4 (108)	5-3/8 (137)	8 (203)	10-5/8 (270)
Effective embedment depth [the anchor is designed for]	h_{ef}	in. (mm)	4.0 (102)	5.0 (127)	7.5 (191)	10.0 (254)
Minimum concrete member thickness	h_{min}	in. (mm)	6.0 (152)	7.0 (178)	9.75 (248)	12.0 (305)
Minimum edge distance	c_{min}	in. (mm)	2.5 (64)	3.0 (76)	4.5 (114)	6.0 (152)
Minimum spacing distance	s_{min}	in. (mm)	3.0 (76)	3.75 (95)	5.625 (143)	7.5 (191)
Installation torque	A36	T_{inst}	11 (15)	29 (38)	70 (95)	118 (160)
	B7 and SS2		37 (50)	70 (95)	118 (160)	221 (300)
Torque wrench / socket size	-	in.	9/16	7/8	11/16	1-1/4

B. Installation parameter

In case of the Preset (PS), installation, the anchor is installed first, and then the attachment (fixture or baseplate) is put in place.

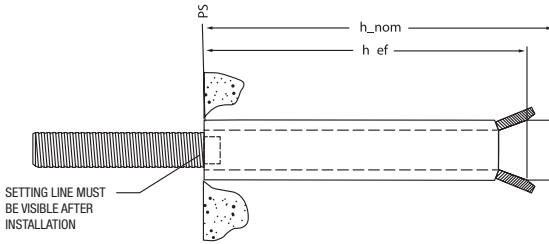

Preset Anchor Installation System Components

Rod Dia.	in. (mm)	3/8"	1/2"		5/8"		3/4"	
		0.875 (22)	1.25 (32)	2 (51)	1.625 (41)	2.375 (60)	2.0 (51)	4.0 (102)
Steel Grade	PS A36	3/8 X 6	1/2 X 7-1/2	1/2 X 8-1/4	5/8 X 10-3/4	5/8 X 11-1/2	3/4 X 14	3/4 X 16
		DFM1311050	DFM1311100	DFM1311150	DFM1311200	DFM1311250	DFM1311300	DFM1311350
	PS B7	3/8 X 6	1/2 X 7-1/2	1/2 X 8-1/4	5/8 X 10-3/4	5/8 X 11-1/2	3/4 X 14	3/4 X 16
		DFM1371050	DFM1371100	DFM1371150	DFM1371200	DFM1371250	DFM1371300	DFM1371350
	PS SS2	3/8 X 6	1/2 X 7-1/2	1/2 X 8-1/4	5/8 X 10-3/4	5/8 X 11-1/2	3/4 X 14	3/4 X 16
		DFM1361050	DFM1361100	DFM1361150	DFM1361200	DFM1361250	DFM1361300	DFM1361350

In case of the Thrubolt (TB) installation, the anchor is installed through the attachment (fixture or baseplate).

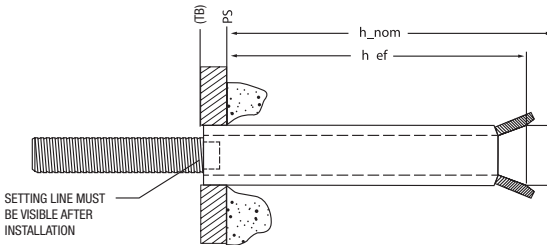

Thrubolt Anchor Installation System Components

Rod Dia.	in. (mm)	3/8"	1/2"		5/8"		3/4"	
		0.875 (22)	1.25 (32)	2 (51)	1.625 (41)	2.375 (60)	2.0 (51)	4.0 (102)
Steel Grade	TB A36	3/8 X 6	1/2 X 7-1/2	1/2 X 8-1/4	5/8 X 10-3/4	5/8 X 11-1/2	3/4 X 14	3/4 X 16
		DFM1311550	DFM1311600	DFM1311650	DFM1311700	DFM1311750	DFM1311800	DFM1311850
	TB B7	3/8 X 6	1/2 X 7-1/2	1/2 X 8-1/4	5/8 X 10-3/4	5/8 X 11-1/2	3/4 X 14	3/4 X 16
		DFM1371550	DFM1371600	DFM1371650	DFM1371700	DFM1371750	DFM1371800	DFM1371850
	TB SS2	3/8 X 6	1/2 X 7-1/2	1/2 X 8-1/4	5/8 X 10-3/4	5/8 X 11-1/2	3/4 X 14	3/4 X 16
		DFM1361550	DFM1361600	DFM1361650	DFM1361700	DFM1361750	DFM1361800	DFM1361850

4. INSTALLATION

A. Power Tools Vacuums



DCV585

SDS+ Hammers



DWV010



DWV012 or DWV015



DCH416

Cordless / Battery / DC Tool

SDSMAX Hammers



D25416

Corded / AC tool



DCH614

Cordless / Battery / DC Tool



D25614

Corded / AC tool

Anchor Size	Hole Diameter	Hole Depth	Hammer	Vacuum	Primary Bit			Undercut Bit		Setting Tool		
					Version	HSDB	HDB	Conventional	HUCB	UCB	Manual	Power
3/8"	11/16"	4-1/4"	SDS+ DCH416 or D25416	DWV010 or DWV012 or DCV585	Preset	DFX11380	DWA54116	DW5808 ¹	DFX21380	DFX21381 ¹	DFX313805	DFX313825
					Thrubolt	-						
1/2"	13/16"	5-3/8"	SDS+ DCH416 or D25416		Preset	DFX11120	DWA54316	DW5814 ¹	DFX21120	DFX21121 ¹	DFX311210	DFX311230
					Thrubolt	-						
5/8"	1"	8"	SDSMAX DCH614 or D25614		Preset	DFX11580	DWA58001	DW5852 ¹	DFX21580 ²	DFX21581 ^{1,2}	DFX315815	DFX315835
					Thrubolt	-						
3/4"	1-1/4"	10-5/8"	SDSMAX DCH614 or D25614	Preset	DFX11340	DWA58115	DW5855 ¹	DFX21340	DFX21341 ¹	DFX313420	DFX313440	
				Thrubolt	-							



DWH050K

¹The hood allows dust free drilling if conventional primary bits or UCB are used; use of hollow bits is suggested



DW5891

²SDSMAX to SDS+ adapter, allowing to use a SDSMAX hammer for a bit with a SDS+ shank; alternatively, use a SDS+ hammer tool

B. Installation instructions

GENERAL / GETTING PREPARED

Power Tool: Hammer and Vacuum

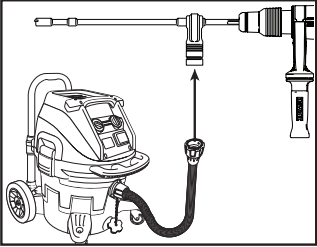

Connect the bit to the proper hammer and, in case of a hollow bit, to the proper vacuum using the DEWALT AirLock™ connector system.

Hollow Bits

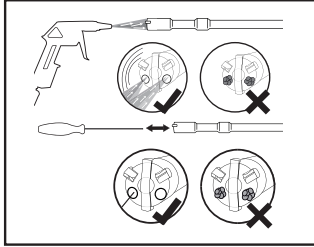

Make sure that air flows freely, clean if required.

Undercut Bits

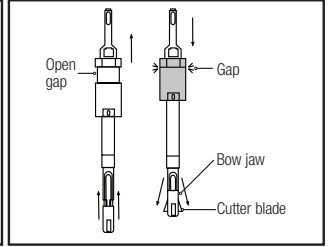

Make sure the cutter blades slides easily over the bow jaw and the gap can be fully closed.

PRIMARY HOLE DRILLING

HOLLOW BITS

Preset Installation

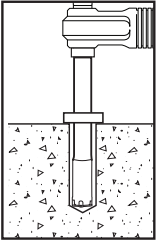

1a. Before drilling, ensure hollow drill bit holes are not clogged. Using a HSDB of proper size, drill a hole into the base material to the required depth, i.e. until the collar of the bit touches the concrete surface. Continue with Step 3.

Thrubolt Installation

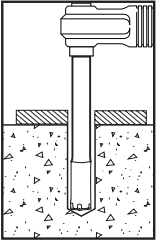

1b. Before drilling, ensure hollow drill bit holes are not clogged. Using a HDB of proper size drill a hole into the base material to the required depth. For this, mark the depth on the bit shank taking the fixture thickness into account. Continue with Step 3.

CONVENTIONAL BITS

Preset Installation

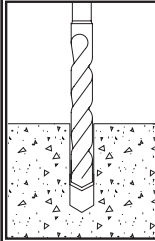

1c. Using the proper drill bit size, drill a hole into the base material to the required depth. The tolerances of the drill bit used should meet the requirements of ANSI Standard B212.15. Mark the depth on the bit. Continue with Step 2.

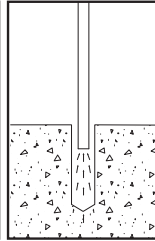

2. Remove dust and debris from the hole following drilling (e.g. suction, forced air). Continue with Step 3.

Thrubolt Installation

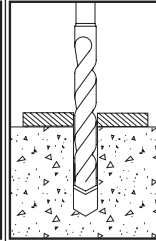

1c. Using the proper drill bit size, drill a hole into the base material to the required depth. The tolerances of the drill bit used should meet the requirements of ANSI Standard B212.15. Mark the depth on the bit taking the fixture thickness into account. Continue with Step 2.

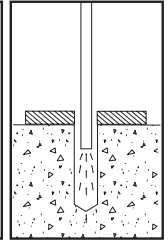

2. Remove dust and debris from the hole following drilling (e.g. suction, forced air). Continue with Step 3.

UNDERCUTTING

HOLLOW BITS

Preset Installation

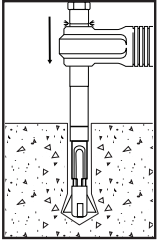

3a. Insert a HUCB of proper size until it hits the bottom of the hole. Start the hammer at low speed and undercut. Undercutting is complete when the stopper sleeve is fully compressed, i.e. the gap is closed. Continue with Step 5.

Thrubolt Installation

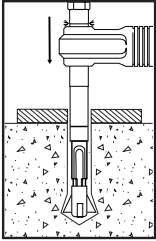

3b. Insert a HUCB of proper size until it hits the bottom of the hole. Start the hammer at low speed and undercut. Undercutting is complete when the stopper sleeve is fully compressed, i.e. the gap is closed. Continue with Step 5.

CONVENTIONAL BITS

Preset Installation

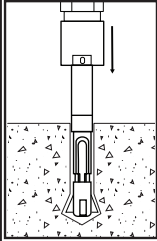

3c. Insert a UCB of proper size until it hits the bottom of the hole. Start the hammer at low speed and undercut. Undercutting is complete when the stopper sleeve is fully compressed, i.e. the gap is closed. Continue with Step 5.

Thrubolt Installation

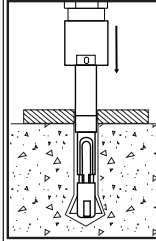

3c. Insert a UCB of proper size until it hits the bottom of the hole. Start the hammer at low speed and undercut. Undercutting is complete when the stopper sleeve is fully compressed, i.e. the gap is closed. Continue with Step 5.

4. Remove dust and debris from the hole following drilling (e.g. suction, forced air).

4. Remove dust and debris from the hole following drilling (e.g. suction, forced air).

ANCHOR SETTING

Preset Installation

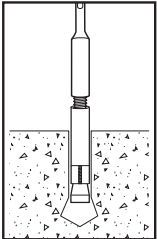

5. Insert the anchor into hole. Place setting sleeve over anchor and drive the sleeve over the cone. For this, use either a setting tool for manual installation or a setting tool for power tool installation. Take care that the thread does not get damaged during installation.

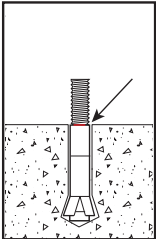

6. Verify that the red setting mark is visible on the threaded rod at or above the sleeve.

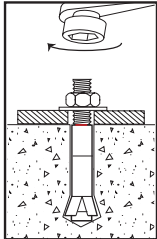

7. Apply proper torque; Do not exceed maximum torque.

Thrubolt Installation

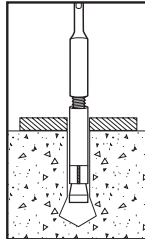

5. Insert the anchor into hole. Place setting sleeve over anchor and drive the sleeve over the cone. For this, use either a setting tool for manual installation or a setting tool for power tool installation. Take care that the thread does not get damaged during installation.

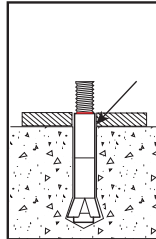

6. Verify that the red setting mark is visible on the threaded rod at or above the sleeve.

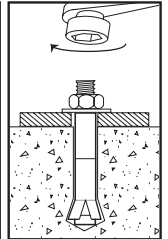

7. Apply proper torque; Do not exceed maximum torque.

5. REPLACING WEAR PARTS

A. Bow jaw



B. Cutter blade



Anchors	Bow Jaw		Cutter Blade
	HUCB	UCB	HUCB & UCB
3/8"	DFX213807	DFX213805	DFX213825
1/2"	DFX211212	DFX211210	DFX211230
5/8"	DFX215817	DFX215815	DFX215835
3/4"	DFX213422	DFX213420	DFX213440

C. Instructions

The cutter blade wears and has to be replaced, depending on the condition of the concrete. Also the bow jaw experience wear at its head over time and needs to be replaced occasionally. The following procedure explains how the cutter blade and the bow jaw, if required, can be changed.

1. Press the pin on the undercutter using a screwdriver

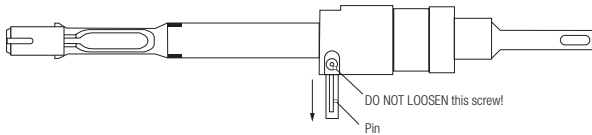

2. Pull out the bow jaw

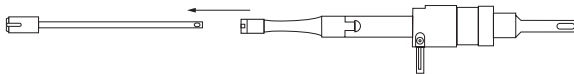

3. Change the cutter blade

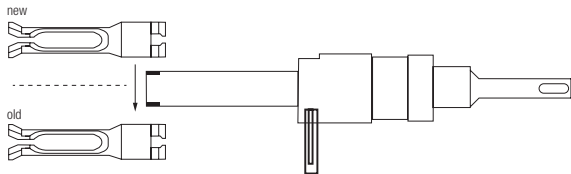

4. Insert the bow jaw

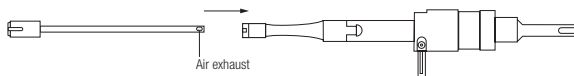

Note: The bow jaw used for the HUCB has an air exhaust on one side. Therefore it is important to ensure that the bow jaw is oriented correctly to match the air inlet in the bit chassis!

5. Align the pin and pinhole and reinsert

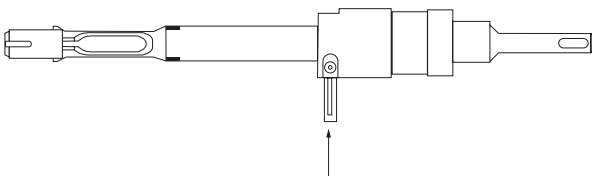

6. TROUBLE SHOOTING

A. Cleaning of primary hollow bit

Hollow bits work best in dry concrete. Take care when drilling in wet concrete. The internal hollow channel of smaller diameter HSDB can clog with concrete dust. It is recommended to occasionally blow through the small hole at the rear of the bit using dry compressed air in case of SDS+ bits. The SDSMAX bits can be cleaned from the inlets at the front using a thin gauge wire to dislodge material build up..

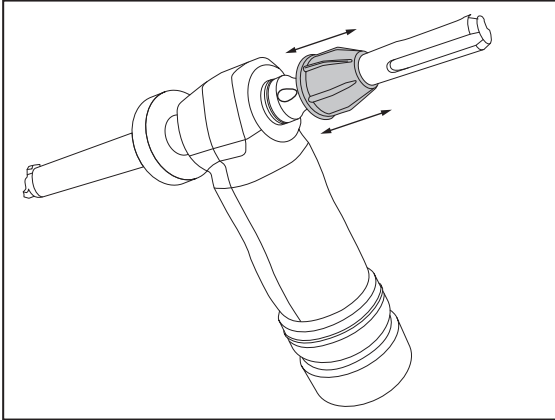

B. Un-jamming of undercut bit

When the cutter blade of the UCB is stuck while undercutting and it cannot be pulled out from the hole, use wrenches as shown in below picture to relieve the cutter blade closed and remove the undercutter from the hole. After removal, retighten the loosened screw and continue undercutting. This feature is not available for HUCB as these do not tend to jam because of the dust constantly removed during undercutting.

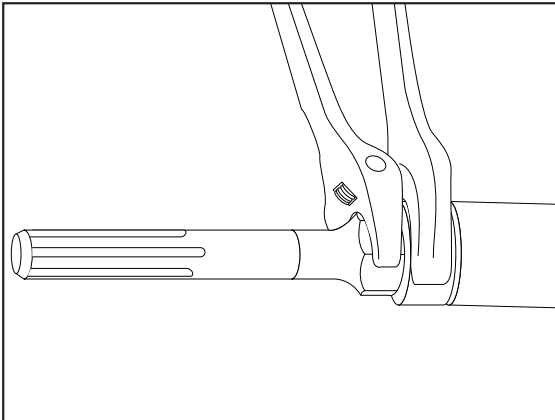

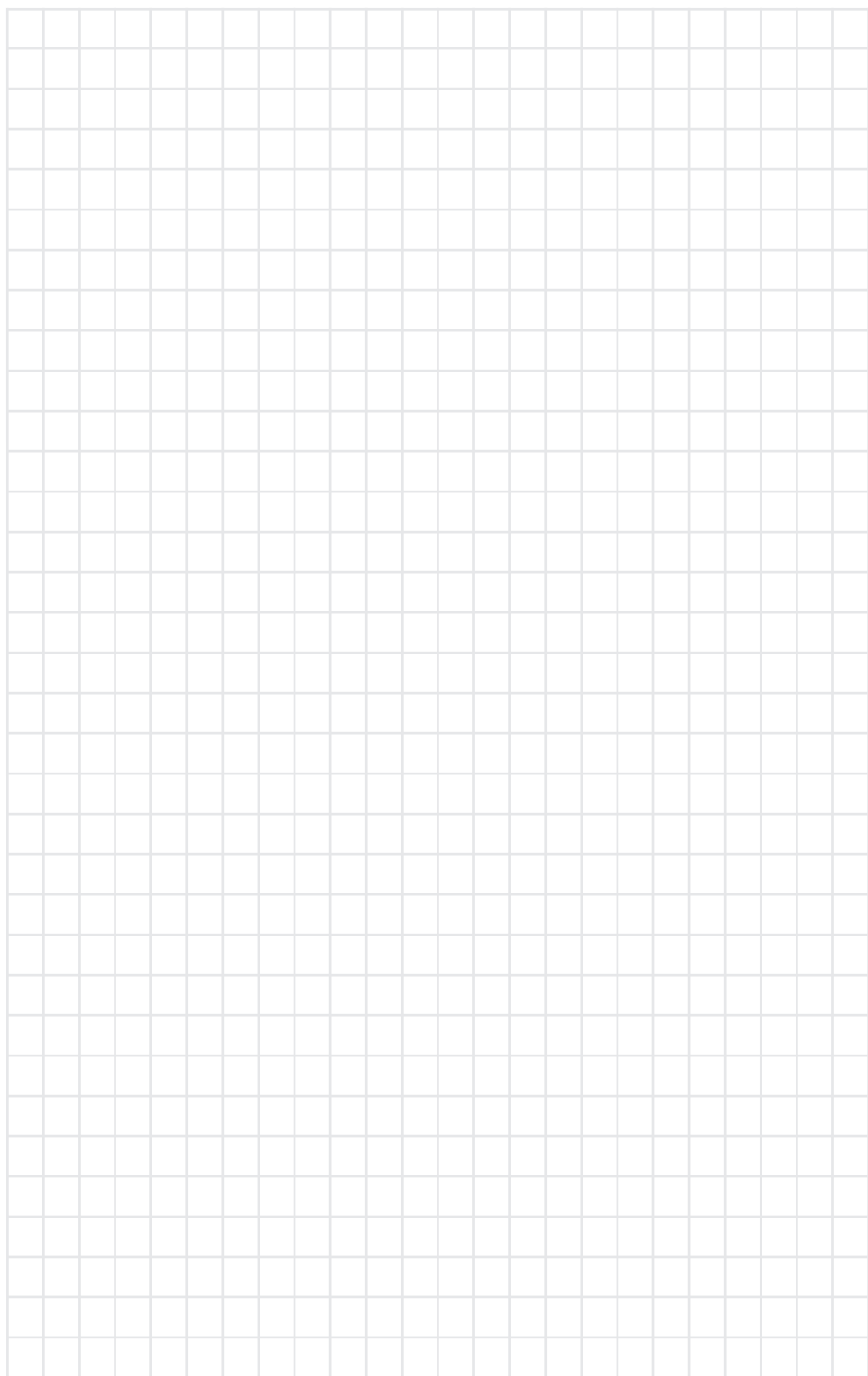

The DEWALT logo is displayed in a bold, black, sans-serif font. The letters are thick and blocky. The word "DEWALT" is centered within a yellow rectangular background. The logo is flanked by two horizontal black lines, one above and one below the text. A registered trademark symbol (®) is located at the end of the word.

ANCHORS & FASTENERS

FOR TECHNICAL ASSISTANCE PLEASE CONTACT:

anchors@DEWALT.com

1-800-524-3244

The information contained herein is accurate to the best of DEWALT's knowledge as of the date of publication and is provided for guidance and informational purposes only. Refer to website for most up to date version of this document. To obtain a project specific certification contact DEWALT engineering at anchors@DEWALT.com.