DEWALT

TOUGHWIRE
CABLE HANGER SYSTEM



CABLE HANGER SYSTEM

PRODUCT CATALOG

TABLE OF CONTENTS

03 PRODUCT OVERVIEW

04 WIRE ATTACHMENTS

Loop End Wire Attachment
Tie-Wire Assembly
Threaded Stud Wire Assembly
Powder Pin 90° Clip Wire Assembly
Stick-E™ 90° Clip Assembly Wire Attachment

09 WIRE LOCKING DEVICES

TOUGHLOCK™ WIRE LOCKING DEVICE
SQUARELOCK™ WIRE LOCKING DEVICE
SQUARELOCK™ PAD WIRE LOCKING DEVICE
STRUTLOCK™ WIRE LOCKING DEVICE

13 WIRE COMPONENTS

D-Clip Wire Component
Threaded Stud Wire Component

15 WIRE ACCESSORIES

Cable Spool Wire Accessory
Cable Cutter Wire Accessory





TOUGHWIRE™
CABLE HANGER SYSTEM

Take advantage of fast, strong, and easy installations with TOUGHWIRE™ Cable Hangers. Combine wire assemblies, wire locking devices, components, and accessories with TOUGHWIRE™ Cable Hangers to create a suspension solution catered to HVAC, sheet metal, electrical, and plumbing/pipe applications.



FAST

TOUGHWIRE™ is up to 28% Faster to Install*

*DEWALT Threaded Stud Wire Assembly Attachment DTW0206T2 and DEWALT TOUGHLOCK™ Wire Locking Device DTWTOUGHLOCK02 vs. traditional threaded rod method.



STRONG

Wire constructions are designed to support a variety of tough hanging applications.



EASY

Securely handle while wearing gloves.



DEWALT® TOUGHWIRE™ Wire Assembly Attachments and Wire Locking Devices have been a game-changer for our construction team compared to other hanging solutions we previously used. We've seen a significant improvement in both efficiency and ease of installation. DEWALT® really considered the end user when developing these products. The packaging has led to more efficient install times with pre-rolled wire.

We've also noticed a difference in the quality of wire, less fraying and more durable, for sure. We've saved time and reduced labor costs thanks to the design and reliability of these products. AMS highly recommends these products for anyone looking for high-quality, versatile wire solutions.**

- Joe Martineck
Associate VP AMS Industries



**AMS Industries received a free sample of DEWALT® TOUGHWIRE™ Wire Assembly Attachments and Wire Locking Devices in exchange for their honest feedback in this testimonial.

WIRE ATTACHMENTS

LOOP END WIRE ATTACHMENT

The Loop End Wire Attachment interfaces with DW1, DW2, and DW3 TOUGHWIRE™ Wire Locking Devices (sold separately). This attachment allows TOUGHWIRE™ to be wrapped around purlins, beams, and other anchor points. This Loop End Wire Attachment then passes back through the loop creating a choke-knot suspension point. The suspension can be used for HVAC, sheet metal, electrical, and plumbing/pipe applications to complete a variety of building services.

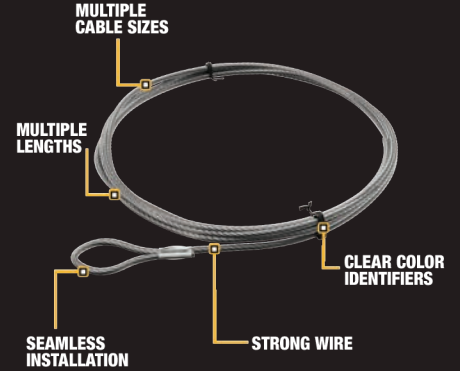

File No.
E542601



SMACNA TRI
Verified

SKU	DESCRIPTION	SIZE RANGE (WIRE ROPE)	WIRE ROPE MATERIAL	SUITABLE BASE MATERIAL	PACK	CTN
DTW0106LE	DW1 x 6 ft. LOOP END	●	Galvanized Steel	Steel, Wood, Concrete	75	300
DTW0112LE	DW1 x 12 ft. LOOP END	●	Galvanized Steel	Steel, Wood, Concrete	50	200
DTW0120LE	DW1 x 20 ft. LOOP END	●	Galvanized Steel	Steel, Wood, Concrete	25	100
DTW0206LE	DW2 x 6 ft. LOOP END	●	Galvanized Steel	Steel, Wood, Concrete	25	100
DTW0212LE	DW2 x 12 ft. LOOP END	●	Galvanized Steel	Steel, Wood, Concrete	25	100
DTW0220LE	DW2 x 20 ft. LOOP END	●	Galvanized Steel	Steel, Wood, Concrete	25	100
DTW0235LE	DW2 x 35 ft. LOOP END	●	Galvanized Steel	Steel, Wood, Concrete	25	100
DTW0306LE	DW3 x 6 ft. LOOP END	●	Galvanized Steel	Steel, Wood, Concrete	25	100
DTW0312LE	DW3 x 12 ft. LOOP END	●	Galvanized Steel	Steel, Wood, Concrete	25	100
DTW0320LE	DW3 x 20 ft. LOOP END	●	Galvanized Steel	Steel, Wood, Concrete	10	40
DTW0335LE	DW3 x 35 ft. LOOP END	●	Galvanized Steel	Steel, Wood, Concrete	15	30

SIZE RANGE (WIRE ROPE): ● DW1 = GREEN ● DW2 = GREY ○ DW3 = BLACK



INCLUSIVE SIZING

Complete a variety of applications with drop lengths ranging from 6 ft. to 35 ft.

WIRE ATTACHMENTS

TIE-WIRE ASSEMBLY WIRE ATTACHMENT

This Tie-Wire Assembly Wire Attachment interfaces with DW2 and DW3 TOUGHWIRE™ Wire Locking Devices (sold separately). This wedge expansion anchor (sold separately) unites the TOUGHWIRE™ suspension system with the Tie-Wire Assembly Wire Attachment. Paired with a TOUGHWIRE™ Wire Locking Device, this wire attachment can be used to quickly suspend a variety of building services including HVAC, sheet metal, electrical, and plumbing/pipe applications. Usage of DEWALT® Hammer Drill (sold separately) required for installing Tie-Wire Assembly Wire Attachments.

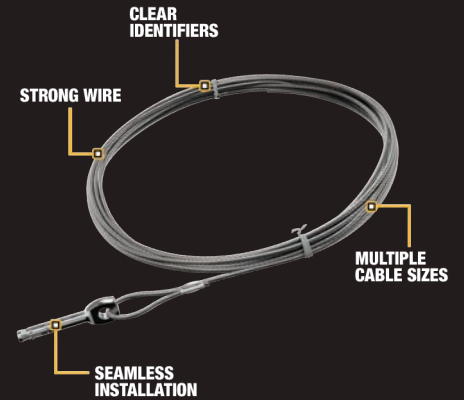

SMACNA TRI
Verified

SKU	DESCRIPTION	END FIXING MATERIAL	SIZE RANGE (WIRE ROPE)	WIRE ROPE MATERIAL	SUITABLE BASE MATERIAL	PACK	CTN
DTW0212TW	DW2 x 12 ft. PWR-STUD	Zinc Plated Carbon Steel	●	Galvanized Steel	Concrete, Lightweight Concrete	25	100
DTW0220TW	DW2 x 20 ft. PWR-STUD	Zinc Plated Carbon Steel	●	Galvanized Steel	Concrete, Lightweight Concrete	25	100
DTW0235TW	DW2 x 35 ft. PWR-STUD	Zinc Plated Carbon Steel	●	Galvanized Steel	Concrete, Lightweight Concrete	25	100
DTW0312TW	DW3 x 12 ft. PWR-STUD	Zinc Plated Carbon Steel	●	Galvanized Steel	Concrete, Lightweight Concrete	25	100
DTW0320TW	DW3 x 20 ft. PWR-STUD	Zinc Plated Carbon Steel	●	Galvanized Steel	Concrete, Lightweight Concrete	10	40
DTW0335TW	DW3 x 35 ft. PWR-STUD	Zinc Plated Carbon Steel	●	Galvanized Steel	Concrete, Lightweight Concrete	15	30

SIZE RANGE (WIRE ROPE): ● DW2 = GREY ○ DW3 = BLACK



DRILLING SOLUTION

Pairs with DEWALT® Anchors and Rotary Hammers (sold separately).

STRONG WIRE

Complete intended applications with a strong galvanized steel 7x7 braided wire construction.

WIRE ATTACHMENTS

THREADED STUD ASSEMBLY WIRE ATTACHMENT

This Threaded Stud Assembly Wire Attachment interfaces with DW2 and DW3 TOUGHWIRE™ Wire Locking Devices. Made from Grade 5 steel, this threaded stud allows for TOUGHWIRE™ to be paired with a wide range of DEWALT® anchors and fasteners and other internally threaded hardware products. Available in two sizes: 3/8 in.-16 x 2 in. and 3/8 in.-16 x 5 in. standard UNC all thread rod. Paired with a TOUGHWIRE™ Wire Locking Device (sold separately), this wire attachment can be used to quickly suspend a variety of building services including HVAC, sheet metal, electrical, and plumbing/pipe applications.

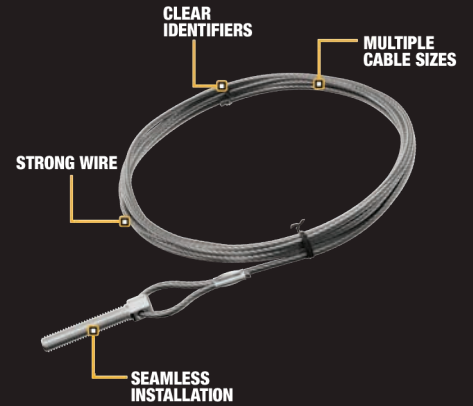

File No.
E542601

SMACNA TRI
Verified

SKU	DESCRIPTION	SIZE RANGE (WIRE ROPE)	END FIXING MATERIAL	WIRE ROPE MATERIAL	PACK	CTN
DTW0206T2	DW2 x 6 ft. STUD 3/8 x 2 in.	●	Carbon Steel	Galvanized Steel	25	100
DTW0212T2	DW2 x 12 ft. STUD 3/8 x 2 in.	●	Carbon Steel	Galvanized Steel	25	100
DTW0220T2	DW2 x 20 ft. STUD 3/8 x 2 in.	●	Carbon Steel	Galvanized Steel	25	100
DTW0235T2	DW2 x 35 ft. STUD 3/8 x 2 in.	●	Carbon Steel	Galvanized Steel	25	100
DTW0306T2	DW3 x 6 ft. STUD 3/8 x 2 in.	●	Carbon Steel	Galvanized Steel	25	100
DTW0312T2	DW3 x 12 ft. STUD 3/8 x 2 in.	●	Carbon Steel	Galvanized Steel	25	100
DTW0320T2	DW3 x 20 ft. STUD 3/8 x 2 in.	●	Carbon Steel	Galvanized Steel	10	40
DTW0335T2	DW3 x 35 ft. STUD 3/8 x 2 in.	●	Carbon Steel	Galvanized Steel	15	30
DTW0212T5	DW2 x 12 ft. STUD 3/8 x 5 in.	●	Carbon Steel	Galvanized Steel	25	100
DTW0220T5	DW2 x 20 ft. STUD 3/8 x 5 in.	●	Carbon Steel	Galvanized Steel	25	100
DTW0312T5	DW3 x 12 ft. STUD 3/8 x 5 in.	●	Carbon Steel	Galvanized Steel	25	100
DTW0320T5	DW3 x 20 ft. STUD 3/8 x 5 in.	●	Carbon Steel	Galvanized Steel	10	40

SIZE RANGE (WIRE ROPE): ● DW2 = GREY ○ DW3 = BLACK

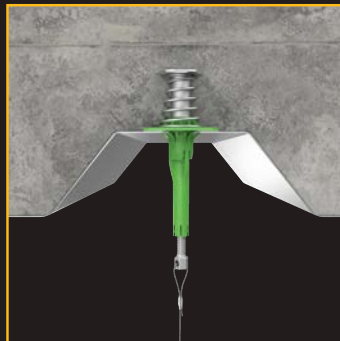

WIRE ATTACHMENTS

POWDER PIN 90° CLIP ASSEMBLY WIRE ATTACHMENT

This Powder Pin 90° Clip Assembly Wire Attachment interfaces with DW1 and DW2 TOUGHWIRE™ Wire Locking Devices (sold separately). This CSI Powder Pin (sold separately) unites the TOUGHWIRE™ suspension system with the 90° clip assembly wire attachment. Paired with a TOUGHWIRE™ wire locking device, this wire attachment can be used to quickly suspend a variety of building services including HVAC, sheet metal, electrical, and plumbing/pipe applications. Usage of DEWALT® Powder-Actuated Tools (sold separately) required for installing Powder Pin 90° Clip Assembly Wire Attachments.

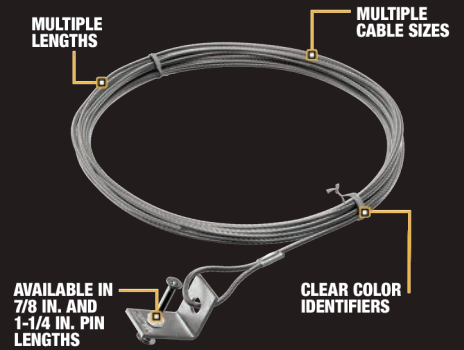

File No.
E542601



SMACNA TRI
Verified

SKU	DESCRIPTION	SIZE RANGE (WIRE ROPE)	END FIXING MATERIAL	WIRE ROPE MATERIAL	SUITABLE BASE MATERIAL	PACK	CTN
DTW0112PP	DW1 x 12 ft. POWDER PIN	●	Carbon Steel	Galvanized Steel	Steel, Concrete, Lightweight Concrete	50	200
DTW0120PP	DW1 x 20 ft. POWDER PIN	●	Carbon Steel	Galvanized Steel	Steel, Concrete, Lightweight Concrete	25	100
DTW0206PP	DW2 x 6 ft. POWDER PIN	●	Carbon Steel	Galvanized Steel	Steel, Concrete, Lightweight Concrete	25	100
DTW0212PP	DW2 x 12 ft. POWDER PIN	●	Carbon Steel	Galvanized Steel	Steel, Concrete, Lightweight Concrete	25	100
DTW0220PP	DW2 x 20 ft. POWDER PIN	●	Carbon Steel	Galvanized Steel	Steel, Concrete, Lightweight Concrete	25	100
DTW0235PP	DW2 x 35 ft. POWDER PIN	●	Carbon Steel	Galvanized Steel	Steel, Concrete, Lightweight Concrete	25	100

SIZE RANGE (WIRE ROPE): ● DW1 = GREEN ● DW2 = GREY



SEAMLESS INSTALLATION

Allows attachment to stay coiled and suspended to avoid contact with users on the jobsite.

WIRE ATTACHMENTS

STICK-E™ 90° CLIP ASSEMBLY WIRE ATTACHMENT

This Stick-E™ 90° Clip Assembly Wire Attachment interfaces with DW1 TOUGHWIRE™ Wire Locking Devices (sold separately). The Stick-E™ 90° Clip Assembly Wire Attachment unites with the TOUGHWIRE™ suspension system with use of a fastener (sold separately). Paired with a TOUGHWIRE™ wire locking device, this wire attachment can be used to quickly suspend a variety of building services including HVAC, sheet metal, electrical, and plumbing/pipe applications. The 20V MAX* Trak-It® C6 Gas Concrete Nailer (sold separately) is required for installing Stick-E™ 90° Clip Wire Attachments.

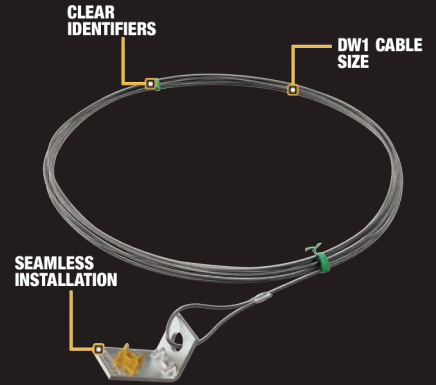

File No.
E542601

SMACNA TRI
Verified

SKU	DESCRIPTION	SIZE RANGE (WIRE ROPE)	END FIXING MATERIAL	WIRE ROPE MATERIAL	SUITABLE BASE MATERIAL	PACK	CTN
DTW0112GP	DW1 x 12 ft. GAS PIN	●	Carbon Steel	Galvanized Steel	Concrete, Lightweight Concrete	50	200
DTW0120GP	DW1 x 20 ft. GAS PIN	●	Carbon Steel	Galvanized Steel	Concrete, Lightweight Concrete	25	100

SIZE RANGE (WIRE ROPE): ● DW1 = GREEN



ATTACHMENT TOOL

Pairs with the Trak-It® C6 fastener and the DEWALT® 20V MAX* Trak-It® C6 Gas Concrete nailer (sold separately).

STREAMLINE DESIGN

Help deliver customer satisfaction with a sleek look ideal for exposed ceiling aesthetics.

*Maximum initial battery voltage (measured without a workload) is 20 volts. Nominal voltage is 18.

WIRE LOCKING DEVICES

TOUGHLOCK™ WIRE LOCKING DEVICES

TOUGHLOCK™ Wire Locking Devices interface with TOUGHWIRE™ DW1, DW2, and DW3 wire rope (sold separately) to create an adjustable and lockable device correlation for HVAC, sheet metal, electrical, and plumbing/pipe applications. Designed to provide ultimate flexibility, TOUGHLOCK™ Wire Locking Devices are designed to help users customize an easy suspension solution to fit the appropriate application. With a large protruded slider pin that allows for tool-free adjustments and side raised grips for ease-of-use when wearing gloves, the TOUGHWIRE™ Wire Locking Devices feature high visibility product identifiers.

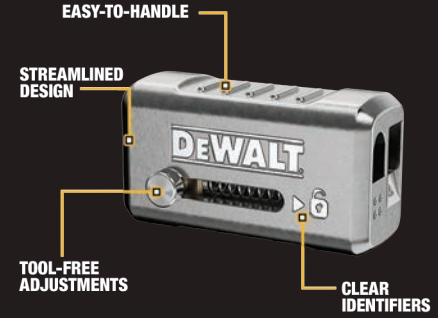

File No.
E542601



SMACNA TRI
Verified

SKU	DESCRIPTION	SIZE RANGE (WIRE ROPE)	DEVICE MATERIAL	SUITABLE MATERIAL PAIRING	PACK	CTN
DTWTOUGHLOCK01	TOUGHLOCK™ DW1	●	Zamac Alloy	TOUGHWIRE™ Wire Rope	100	1000
DTWTOUGHLOCK02	TOUGHLOCK™ DW2	●	Zamac Alloy	TOUGHWIRE™ Wire Rope	50	500
DTWTOUGHLOCK03	TOUGHLOCK™ DW3	●	Zamac Alloy	TOUGHWIRE™ Wire Rope	25	150

SIZE RANGE (WIRE ROPE): ● DW1 = GREEN ● DW2 = GREY ○ DW3 = BLACK

TOUGHLOCK™ APPLICATIONS



WIRE LOCKING DEVICES

SQUARELOCK™ & SQUARELOCK™ PAD WIRE LOCKING DEVICES

SQUARELOCK™ and SQUARELOCK™ PAD Wire Locking Devices interface with TOUGHWIRE™ DW2 and DW3 wire rope (sold separately) to create an adjustable and lockable device correlation for HVAC, sheet metal, electrical, and plumbing/pipe applications. These devices are designed to provide flexibility to customize a suspension solution to fit the appropriate application. Features a large protruded slider pin that allows for tool-free adjustability and the L-shaped design quickly attaches to hardware material. Product identifiers help correctly pair to other TOUGHWIRE™ parts.

SQUARELOCK™ PAD products are also offered and feature an EPDM gasket pad engineered into the device to help dampen sound and vibration.



SMACNA TRI
Verified

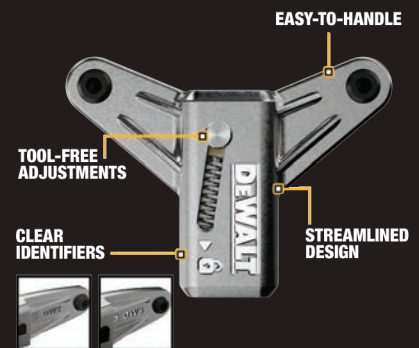
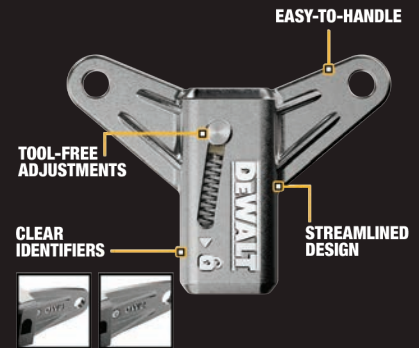

SKU	DESCRIPTION	SIZE RANGE (WIRE ROPE)	DEVICE MATERIAL	SUITABLE MATERIAL PAIRING	PACK	CTN
DTWSQLOCK02	SQUARELOCK™ DW2	●	Zamac Alloy	TOUGHWIRE™ Wire Rope	50	300
DTWSQLOCK03	SQUARELOCK™ DW3	●	Zamac Alloy	TOUGHWIRE™ Wire Rope	25	150
DTWSQLOCKP02	SQUARELOCK™ PAD DW2	●	Zamac Alloy	TOUGHWIRE™ Wire Rope	50	300
DTWSQLOCKP03	SQUARELOCK™ PAD DW3	●	Zamac Alloy	TOUGHWIRE™ Wire Rope	25	150

SIZE RANGE (WIRE ROPE): ● DW2 = GREY ○ DW3 = BLACK

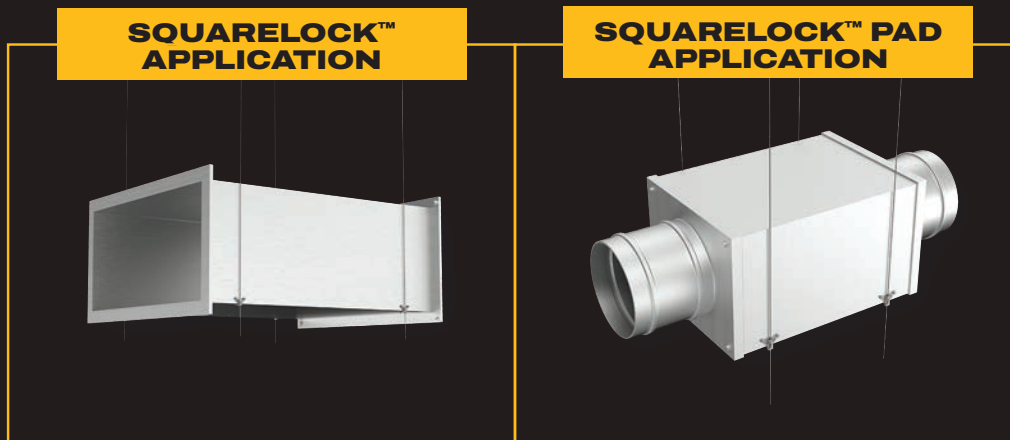

WIRE LOCKING DEVICES

“

For several weeks, I have been utilizing the DEWALT® TOUGHWIRE™ cable hanger system for my duct hanging needs. A key feature that has contributed to reduced issues and enhanced workflow is the color-coded labels on the packaging. Each cable size is assigned a unique color on the packaging that corresponds to the color of the corresponding accessory box. In contrast, some competitors label the boxes with small lettering that can be challenging to discern, so when a runner retrieves the cable and accessories, there is a risk of mismatching the sizes, leading to errors. The DEWALT® TOUGHWIRE™ packaging and the color-coding system, effectively provides a universal method of identification, minimizing the potential for lost time.

- **Caio Torres**
Project Manager/
Sheetmetal Mechanic*

”

**Received free DEWALT® TOUGHWIRE™ cable hanger products in exchange for their testimonial.*



CLEAR IDENTIFIERS

Outer packaging sticker colors to ensure the correct device is paired with the correct attachment.



WIRE LOCKING DEVICES

STRUTLOCK™ WIRE LOCKING DEVICES

STRUTLOCK™ Wire Locking Devices interface with TOUGHWIRE™ DW2 and DW3 wire rope (sold separately) to create an adjustable and lockable device correlation for HVAC, sheet metal, electrical, and plumbing/pipe applications. This device is installed into the strut or channel profiles used to hang trapeze supports. Featuring tool-free adjustability and locking, the TOUGHWIRE™ Wire Locking Devices are equipped with high visibility product identifiers. Get right to work with the included square washer and strut nut.

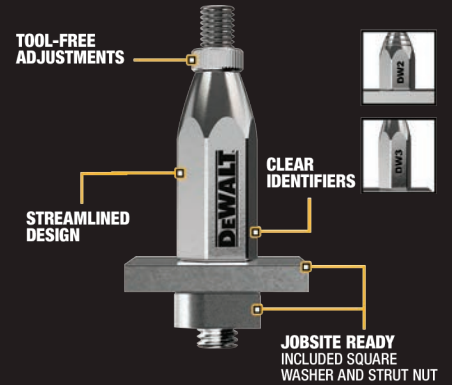

File No.
E542601



SMACNA TRI
Verified

SKU	DESCRIPTION	SIZE RANGE (WIRE ROPE)	DEVICE MATERIAL	SUITABLE MATERIAL PAIRING	PACK	CTN
DTWSTRUTLOCK02	STRUTLOCK™ DW2	●	Zinc Plated	TOUGHWIRE™ Wire Rope	15	90
DTWSTRUTLOCK03	STRUTLOCK™ DW3	●	Zinc Plated	TOUGHWIRE™ Wire Rope	10	60

SIZE RANGE (WIRE ROPE): ● DW2 = GREY ○ DW3 = BLACK

TOOL-FREE ADJUSTMENTS

Easily push to adjust and tighten the lock.



WIRE COMPONENTS

D-CLIP WIRE COMPONENT

The D-Clip Wire Component is a one piece clip that is used to fasten TOUGHWIRE™ to the mounting surface. Can be mounted on flat or sloped surfaces. TOUGHWIRE™ Loop End Wire Assembly products (sold separately) are looped through the D-Clip, then anchored to the structure with a variety of DEWALT® Anchors and Fasteners (sold separately).



SMACNA TRI
Verified

SKU	DESCRIPTION	COMPONENT MATERIAL	HOLE SIZE	SUITABLE MATERIAL PAIRING	PACK	CTN
DTWDCLIP025	D-CLIP 1/4 in.	Zamac Alloy	5/16"	TOUGHWIRE™ Loop End Wire Assembly	50	300
DTWDCLIP044	D-CLIP 7/16 in.	Zamac Alloy	1/2"	TOUGHWIRE™ Loop End Wire Assembly	50	300

		SCREW-BOLT+™ [ICC-ES ESR-3889]		POWER-STUD®+ SD1 [ICC-ES ESR-2818]		ULTRACON®	SPIKE®	
ANCHOR DIAMETER		1/4 in.	3/8 in.	1/4 in.	3/8 in.	5/16 in.	1/4 in.	3/8 in.
D-CLIP 1/4 in.		✓		✓		✓	✓	
D-CLIP 7/16 in.			✓		✓			✓

Please reach out to your local DEWALT representative with any questions on anchor pairings (sold separately).

WIRE COMPONENTS

THREADED STUD WIRE COMPONENT

The Threaded Stud Wire Component is made of a Grade 5 steel that allows for TOUGHWIRE™ Accessories, Components, and Wire Locking Devices to be paired with a wide range of DEWALT® Anchors and Fasteners and other internally threaded hardware products (sold separately). Available in two sizes: 3/8 in.-16 x 2 in. and 3/8 in.-16 x 5 in. standard UNC all-thread rod. Connected with a TOUGHWIRE™ wire locking device, this threaded stud can be used to suspend a variety of MEP building systems including HVAC, sheet metal, electrical, and plumbing/pipe applications.

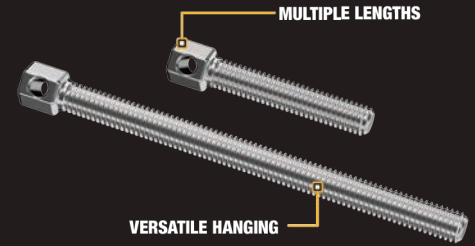



















SMACNA TRI Verified

SKU	DESCRIPTION	COMPONENT MATERIAL	SIZE RANGE	SUITABLE MATERIAL PAIRING	PACK	CTN
DTWSTUD038X02	THREADED STUD 3/8 x 2 in.	Carbon Steel	3/8 x 2 in.	TOUGHWIRE™ Wire Rope	50	300
DTWSTUD038X05	THREADED STUD 3/8 x 5 in.	Carbon Steel	3/8 x 5 in.	TOUGHWIRE™ Wire Rope	50	300

SUGGESTED ANCHOR PAIRINGS



	MINI DROPIN™	STEEL DROPIN™	SNAKE+® [ICC-ES ESR-2272]	MINI-UNDERCUT+™ [ICC-ES ESR-3912]	HANGER-MATE®+ [ICC-ES ESR-3889]	HANGER-MATE®	SUSPENDER®	BANG-IT®+ [ICC-ES ESR-3657]	WOOD-KNOCKER®II+ / PAN-KNOCKER®II+ [ICC-ES ESR-3657]
INTERNAL ANCHOR DIAMETER	3/8 in.	3/8 in.	3/8 in.	3/8 in.	3/8 in.	3/8 in.	3/8 in.	3/8 in.	3/8 in.
THREADED STUD 3/8 in. x 2 in.									
THREADED STUD 3/8 in. x 5 in.									

Please reach out to your local DEWALT representative with any questions on anchor pairings (sold separately).

WIRE ACCESSORIES

CABLE SPOOL WIRE ACCESSORY

This Cable Spool Wire Accessory is available in 330 ft. and 650 ft. lengths with wire sizes DW1, DW2, and DW3. Used in conjunction with DEWALT® TOUGHWIRE™ components for suspension systems. Suspension can be used for HVAC, sheet metal, electrical, and plumbing/pipe applications to complete a variety of building services.

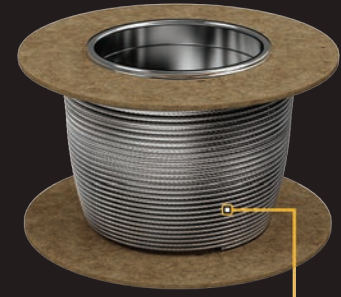

GALVANIZED STEEL 7X7 BRAIDED WIRE



SMACNA TRI Verified

SKU	DESCRIPTION	SIZE RANGE (WIRE ROPE)	WIRE ROPE MATERIAL	SUITABLE MATERIAL PAIRING	PACK
DTWSPOOL01X650	CABLE SPOOL DW1 x 650 ft.	●	Galvanized Steel	TOUGHWIRE™ Products	4
DTWSPOOL02X650	CABLE SPOOL DW2 x 650 ft.	●	Galvanized Steel	TOUGHWIRE™ Products	3
DTWSPOOL03X330	CABLE SPOOL DW3 x 330 ft.	●	Galvanized Steel	TOUGHWIRE™ Products	4

SIZE RANGE (WIRE ROPE): ● DW1 = GREEN ● DW2 = GREY ○ DW3 = BLACK

CABLE CUTTER WIRE ACCESSORY

Cut multiple wire sizes DW1, DW2, and DW3 with this Cable Cutter Wire Accessory. DEWALT® Cable Cutter Wire Accessory is made only to be paired with TOUGHWIRE™ products.



SKU	DESCRIPTION	COMPONENT MATERIAL	SUITABLE MATERIAL PAIRING	PACK	CTN
DTWHANDCUTTER	HAND CUTTER	Carbon Steel	TOUGHWIRE™ Wire Rope	10	60





FAST – STRONG – EASY

Systemize Your Cable Hangers
With DEWALT® TOUGHWIRE™.



Learn more at
DEWALT.COM/TOUGHWIRE