

ICC-ES Evaluation Report

ESR-2582

Reissued February 2025



This report also contains:

- [City of LA Supplement](#)
- [FL Supplement w/ HVHZ](#)
- See [ELC-2582](#) for [National Building Code of Canada](#)

Subject to renewal February 2026

ICC-ES Evaluation Reports are not to be construed as representing aesthetics or any other attributes not specifically addressed, nor are they to be construed as an endorsement of the subject of the report or a recommendation for its use. There is no warranty by ICC Evaluation Service, LLC, express or implied, as to any finding or other matter in this report, or as to any product covered by the report.

Copyright © 2025 ICC Evaluation Service, LLC. All rights reserved.

<p>DIVISION: 03 00 00— CONCRETE</p> <p>Section: 03 16 00— Concrete Anchors</p> <p>DIVISION: 05 00 00— METALS</p> <p>Section: 05 05 19—Post- installed Concrete Anchors</p>	<p>REPORT HOLDER: DEWALT</p> 	<p>EVALUATION SUBJECT:</p> <p>AC100+ GOLD® ADHESIVE ANCHOR SYSTEM IN CRACKED AND UNCRACKED CONCRETE (DEWALT)</p>	
---	--	--	---

1.0 EVALUATION SCOPE

Compliance with the following codes:

- 2024, 2021, 2018 and 2015 [International Building Code® \(IBC\)](#)
- 2024, 2021, 2018 and 2015 [International Residential Code® \(IRC\)](#)

Main references of this report are for the 2024 IBC and IRC. See [Table 11](#) and [Table 12](#) for applicable sections of the code for previous IBC and IRC editions.

Property evaluated:

Structural

2.0 USES

The AC100+ Gold adhesive anchor system is used as anchorage in cracked and uncracked normal weight concrete or lightweight concrete having a specified compressive strength, f'_c , of 2,500 psi to 8,500 psi (17.2 MPa to 58.6 MPa) to resist static, wind, or earthquake (Seismic Design Categories A through F) tension and shear loads in 1/2-, 5/8-, 3/4-, 7/8-, 1- and 1 1/4-inch-diameter (12.7, 15.9, 19.1, 22.2, 25.4 and 31.8 mm) threaded steel rods and No. 4 through No. 10 steel reinforcing bars; and used as anchorage in uncracked normal weight concrete only having a specified compressive strength, f'_c , of 2,500 psi to 8,500 psi (17.2 MPa to 58.6 MPa) to resist static, wind and earthquake (IBC Seismic Design Categories A and B only) tension and shear loads in 3/8-inch-diameter (9.5 mm) threaded steel rods and No. 3 steel reinforcing bars in hammer-drilled holes.

The anchor system complies with anchors as described in Section 1901.3 of the 2024 IBC. The anchor systems may also be used where an engineered design is submitted in accordance with Section R301.1.3 of the IRC.

3.0 DESCRIPTION

3.1 General:

The AC100+ Gold Adhesive is comprised of AC100+ Gold two-component adhesive filled in cartridges, static mixing nozzles, manual or powered dispensing tools, hole cleaning equipment, and adhesive injection accessories. The AC100+ Gold adhesive may be used with continuously threaded steel rods or deformed steel reinforcing bars.

Product names for the report holder is presented in the following table of this report.

Company Name	Adhesive Product Name
DEWALT	AC100+ Gold®
	AC100-PRO (outside the Americas)

The primary components of the AC100+ Gold Adhesive Anchor System, including the AC100+ Gold adhesive cartridge, static mixing nozzle, the nozzle extension tube and steel anchor elements, are shown in [Figure 3](#) of this report. Manufacturer's printed installation instructions (MPII) and parameters, included with each adhesive unit package, are shown in [Figure 4](#) of this report.

3.2 Materials:

3.2.1 AC100+ Gold Adhesive: The AC100+ Gold adhesive is an injectable two-component vinyl ester adhesive. The two components are kept separate by means of a labeled dual-cylinder cartridge. The two components combine and react when dispensed through a static mixing nozzle, supplied by DEWALT, which is attached to the cartridge. AC100+ Gold is available in: coaxial cartridges: 9.5-ounce (280 mL) and 14-ounce (420 mL), and side-by-side cartridges: 28-ounce (825 mL). Each cartridge label is marked with the adhesive expiration date. The shelf life, as indicated by the expiration date, applies to an unopened cartridge stored in a dry, dark, and cool environment.

3.2.2 Hole Cleaning Equipment: Hole cleaning equipment is comprised of steel wire brushes supplied by DEWALT, and air blowers which are shown in [Figure 4](#) of this report.

3.2.3 Dispensers: AC100+ Gold adhesive must be dispensed with manual dispensers, pneumatic dispensers, or electric powered dispensers supplied by DEWALT.

3.2.4 Steel Anchor Elements:

3.2.4.1 Threaded Steel Rods: Threaded steel rods must be clean and continuously threaded (all-thread) in diameters described in [Table 1](#) of this report. The embedded portions of the threaded rods must be clean, straight, and free of mill scale, rust and other coatings (other than zinc) that may impair the bond with the adhesive. Specifications for grades of threaded rod, including the mechanical properties, and corresponding nuts, are included in [Table 2](#). Carbon steel threaded rods may be furnished with a minimum 0.0002-inch-thick (0.005 mm) zinc electroplated coating complying with ASTM B633SC 1 or a minimum 0.0021-inch-thick (0.053 mm) mechanically deposited zinc coating complying with ASTM B695, Class 55; or hot dip galvanized zinc coating complying with ASTM A153, Class C or D. The stainless steel threaded rods must comply with [Table 2](#) of this report. Steel grades and types of material (carbon, stainless) for the washers and nuts must match the threaded rods. Threaded steel rods must be clean, straight and free of indentations or other defects along their length. The embedded end may be flat cut or cut on the bias to a chisel point.

3.2.4.2 Steel Reinforcing Bars: Steel reinforcing bars must be deformed reinforcing bars (rebar) in sizes as described in [Table 1](#) of this report. The embedded portions of reinforcing bars must be clean, straight, and free of mill scale, rust and other coatings (other than zinc) that may impair the bond with the adhesive. Reinforcing bars must not be bent after installation except as set forth in ACI 318-19 Section 26.6.3.2 (b) with the additional condition that the bars must be bent cold, and heating of reinforcing bars to facilitate field bending is not permitted.

3.2.4.3 Ductility: In accordance with ACI 318-19 Section 2.3, in order for a steel anchor element to be considered ductile, the tested elongation must be at least 14 percent and reduction of area must be at least 30 percent. Steel elements with a tested elongation of less than 14 percent or a reduction of area less than 30 percent, or both, are considered brittle. Values for various steel materials are provided in [Table 2](#) of this report. Where values are nonconforming or unstated, the steel must be considered brittle.

3.3 Concrete:

Normal weight concrete and lightweight concrete must comply with Sections 1903 and 1905 of the IBC, as applicable. The specified compressive strength of the concrete must be from 2,500 psi to 8,500 psi (17.2 MPa to 58.6 MPa).

4.0 DESIGN AND INSTALLATION

4.1 Strength Design:

General: The design strength of anchors under the 2024 IBC, as well as the 2024 IRC must be determined in accordance with ACI 318-19 and this report.

The strength design of anchors must comply with ACI 318-19 Section 17.5.1.2 except as required in ACI 318-19 Section 17.10.

Design parameters are provided in [Table 4](#) through [Table 8](#) of this report. Strength reduction factors, ϕ , as given in ACI 318-19 Section 17.5.3, must be used for load combinations calculated in accordance with Section 1605.1 of the 2024 IBC and ACI 318-19 Section 5.3

4.1.1 Static Steel Strength in Tension: The nominal static steel strength of a single anchor in tension, N_{sa} , in accordance with ACI 318-19 Section 17.6.1.2 and the associated strength reduction factors, ϕ , in accordance with ACI 318-19 Section 17.5.3, are provided in [Table 4](#) and [Table 5](#) of this report for the anchor element types included in this report. See [Table 1](#) for design use and table index.

4.1.2 Static Concrete Breakout Strength in Tension: The nominal concrete breakout strength of a single anchor or group of anchors in tension, N_{cb} or N_{cbg} , must be calculated in accordance with ACI 318-19 Section 17.6.2 with the following addition:

The basic concrete breakout strength of a single anchor in tension, N_b , must be calculated in accordance with ACI 318-19 Section 17.6.2.2 using the selected values of $k_{c,cr}$ and $k_{c,uncr}$ as provided in the tables of this report. Where analysis indicates no cracking in accordance with ACI 318-19 Section 17.6.2.5, N_b must be calculated using $k_{c,uncr}$ and $\Psi_{c,N} = 1.0$. See [Table 1](#) for additional design information. See ACI 318-19 Section 17.2.4 for modification factor, λ_a , for lightweight concrete. The value of f'_c used for calculation must be limited to 8,000 psi (55 MPa) in accordance with ACI 318-19 Section 17.3.1. Additional information for the determination of nominal bond strength in tension is given in Section 4.1.4 of this report.

4.1.3 Static Bond Strength in Tension: The nominal static bond strength of a single adhesive anchor or group of adhesive anchors in tension, N_a or N_{ag} , must be calculated in accordance with ACI 318-19 Section 17.6.5. Bond strength values ($\tau_{k,cr}$, $\tau_{k,uncr}$) are a function of concrete compressive strength (f'_c), concrete state (cracked, uncracked), and installation conditions (dry concrete, water-saturated concrete, water-filled holes). Bond strength values must further be modified with the factor K_{nn} for cases where the holes are water-filled at the time of anchor installation (K_{wfl}). Special inspection level is qualified as periodic for all anchors except as noted in Section 4.4 of this report. The selection of continuous special inspection level does not provide an increase in anchor category or associated strength reduction factors for design. The following table summarizes the requirements:

CONCRETE STATE	DRILLING METHOD	BOND STRENGTH	CONCRETE STRENGTH	PERMISSIBLE INSTALLATION CONDITIONS	ASSOCIATED STRENGTH REDUCTION FACTOR
Cracked and uncracked	Hammer-drill	$\tau_{k,cr}$ or $\tau_{k,uncr}$	f'_c	Dry concrete	ϕ_d
				Water-saturated concrete	ϕ_{ws}
				Water-filled hole (flooded)	ϕ_{wfl}

The bond strength values in [Table 7](#) and [Table 8](#) for hammer-drilled holes, correspond to concrete compressive strength f'_c equal to 2,500 psi (17.2 MPa) in normal weight concrete. For concrete compressive strength, f'_c between 2,500 psi and 8,000 psi (17.2 MPa and 55.2 MPa), the tabulated characteristic bond strength may be increased by a factor of $(f'_c / 2,500)^{0.13}$ [For SI: $(f'_c / 17.2)^{0.13}$]. Where applicable, the modified bond strength values must be used in lieu of $\tau_{k,cr}$ and $\tau_{k,uncr}$ in ACI 318-19 Eq. 17.6.5.1.2b and 17.6.5.2.1. The resulting nominal bond strength must be multiplied by the associated strength reduction factor ϕ_d , ϕ_{ws} or ϕ_{wfl} , as applicable.

[Figure 2](#) of this report presents a bond strength design selection flowchart. Strength reduction factors for determination of the bond strength are given in [Table 7](#) and [Table 8](#) of this report. See [Table 1](#) for index of design tables. Adjustments to the bond strength may also be made for increased concrete compressive strength as noted above and in the footnotes to the corresponding tables. For anchors in lightweight concrete see ACI 318-19 Section 17.2.4.

4.1.4 Static Steel Strength in Shear: The nominal static strength of a single anchor in shear, as governed by the steel, V_{sa} , in accordance with ACI 318-19 Section 17.7.1.2 and the strength reduction factors, ϕ , in accordance with ACI 318-19 Section 17.5.3, are given in [Table 4](#) and [Table 5](#) of this report for the anchor element types included in this report. See [Table 1](#) for index of design tables.

4.1.5 Static Concrete Breakout Strength in Shear: The nominal concrete breakout strength of a single anchor or group of anchors in shear, V_{cb} or V_{cbg} , must be calculated in accordance with ACI 318-19 Section 17.7.2, based on information given in [Table 6](#) of this report. The basic concrete breakout strength of a single anchor in shear, V_b , must be calculated in accordance with ACI 318-19 Section 17.7.2.2, using the values of d

given in [Table 6](#) for the corresponding anchor steel in lieu of d_a . In addition, h_{ef} must be substituted for ℓ_e . In no case must ℓ_e exceed $8d$. See ACI 318-19 Section 17.2.4 for modification factor, λ_a , for lightweight concrete. The value of f'_c must be limited to a maximum of 8,000 psi (55 MPa) in accordance with ACI 318-19 Section 17.3.1.

4.1.6 Static Concrete Pryout Strength in Shear: The nominal static pryout strength of a single anchor or group of anchors in shear, V_{cp} or $V_{cp,g}$, shall be calculated in accordance with ACI 318-19 Section 17.7.3.

4.1.7 Interaction of Tensile and Shear Forces: For designs that include combined tension and shear, the interaction of tension and shear loads must be calculated in accordance with ACI 318-19 Section 17.8.

4.1.8 Minimum Member Thickness h_{min} , Anchor Spacing s_{min} , Edge Distance c_{min} : In lieu of ACI 318-19 Section 17.9.2 values of s_{min} and c_{min} described in this report must be observed for anchor design and installation. The minimum member thicknesses, h_{min} , described in this report must be observed for anchor design and installation. For adhesive anchors that will remain untorqued, ACI 318-19 Section 17.9.3 applies.

For anchors that will be torqued during installation, the maximum torque, T_{max} , must be reduced for edge distances less than five anchor diameters ($5d$). T_{max} is subject to the edge distance, c_{min} , and anchor spacing, s_{min} , and shall comply with the following requirements:

MAXIMUM TORQUE SUBJECT TO EDGE DISTANCE			
NOMINAL ANCHOR SIZE, d	MIN. EDGE DISTANCE, c_{min}	MIN. ANCHOR SPACING, s_{min}	MAXIMUM TORQUE, T_{max}
all sizes	$5d$	$5d$	$1.0 \cdot T_{max}$
$\frac{3}{8}$ in. to 1 in. #3 to #8	1.75 in. (45 mm)	$5d$	$0.45 \cdot T_{max}$
$1\frac{1}{4}$ in. #9 to #10	2.75 in. (70 mm)		

For values of T_{max} , see [Table 9](#) and [Figure 4](#) of this report.

4.1.9 Critical Edge Distance c_{ac} and $\psi_{cp,Na}$: The modification factor $\psi_{cp,Na}$, must be determined in accordance with ACI 318-19 Section 17.6.5.5 except as noted below:

For all cases where $c_{Na}/c_{ac} < 1.0$, $\psi_{cp,Na}$ determined from ACI 318-19 Eq. 17.6.5.5.1b, need not be taken less than c_{Na}/c_{ac} . For all other cases, $\psi_{cp,Na}$ shall be taken as 1.0.

The critical edge distance, c_{ac} must be calculated according to ACI 318-19 Eq. 17.6.5.5.1c, in lieu of ACI 318-19 17.9.5, as applicable.

$$c_{ac} = h_{ef} \cdot \left(\frac{\tau_{k,uncr}}{1160} \right)^{0.4} \cdot \left[3.1 - 0.7 \frac{h}{h_{ef}} \right]$$

(ACI 318-19 Eq. 17.6.5.5.1c)

where

$\left[\frac{h}{h_{ef}} \right]$ need not be taken as larger than 2.4; and

$\tau_{k,uncr}$ = the characteristic bond strength stated in the tables of this report whereby $\tau_{k,uncr}$ need not be taken as larger than:

$$\tau_{k,uncr} = \frac{k_{uncr} \sqrt{h_{ef} f'_c}}{\pi \cdot d_a} \quad \text{Eq. (4-1)}$$

4.1.10 Design Strength in Seismic Design Categories C, D, E and F: In structures assigned to Seismic Design Category C, D, E or F under the IBC or IRC, anchors must be designed in accordance with ACI 318-19 Section 17.10, except as described below.

The nominal steel shear strength, V_{sa} , must be adjusted by $\alpha_{V,seis}$ as given in [Tables 4](#) and [5](#) for the corresponding anchor steel. The nominal bond strength $\tau_{k,cr}$ must be adjusted by $\alpha_{N,seis}$ as given in [Table 7](#) for threaded rods. An adjustment to the nominal bond strength $\tau_{k,cr}$ is not required for reinforcing bars ($\alpha_{N,seis} = 1.0$).

4.2 Allowable Stress Design (ASD):

4.2.1 General: For anchors designed using load combinations in accordance with Section 1605.1 of the 2024 IBC (Allowable Stress Design) loads must be established using the equations below:

$$T_{allowable,ASD} = \phi N_n / \alpha \quad \text{(Eq. 4-2)}$$

and

$$V_{allowable,ASD} = \phi V_n / \alpha \quad (\text{Eq. 4-3})$$

where

$T_{allowable,ASD}$ = Allowable tension load (lbf or kN).

$V_{allowable,ASD}$ = Allowable shear load (lbf or kN).

ϕN_n = Lowest design strength of an anchor or anchor group in tension as determined in accordance with ACI 318-19 Chapter 17 and 2024 IBC Section 1905.7; and Section 4.1 of this report, as applicable (lbf or kN).

ϕV_n = Lowest design strength of an anchor or anchor group in shear as determined in accordance with ACI 318-19 Chapter 17 and 2024 IBC Section 1905.7 and Section 4.1 of this report, as applicable (lbf or kN).

α = Conversion factor calculated as a weighted average of the load factors for the controlling load combination. In addition, α must include all applicable factors to account for non-ductile failure modes and required over-strength.

4.2.2 Interaction of Tensile and Shear Forces: Interaction must be calculated in accordance with ACI 318-19 Section 17.8 as follows:

For shear loads $V \leq 0.2 V_{allowable,ASD}$, the full allowable load in tension shall be permitted.

For tension loads $T \leq 0.2 T_{allowable,ASD}$, the full allowable load in shear shall be permitted.

For all other cases:

$$\frac{T}{T_{allowable,ASD}} + \frac{V}{V_{allowable,ASD}} \leq 1.2 \quad \text{Eq. (4-4)}$$

4.3 Installation:

Installation parameters are illustrated in [Figure 4](#) of this report. Installation must be in accordance with ACI 318-19 Section 26.7.2. Anchor locations must comply with this report and the plans and specifications approved by the code official. Installation of the AC100+ Gold Adhesive Anchor System must conform to the manufacturer's printed installation instructions (MPII) as reproduced in each unit package as described in [Figure 4](#). The injection tools, mixing nozzles, wire brushes, air blowers, and piston plugs along with the adhesive cartridges must be supplied by the manufacturer, as described in [Figure 4](#) of this report.

The adhesive anchor system may be used for upwardly inclined orientation applications (e.g. overhead). Upwardly inclined and horizontal orientation applications are to be installed using piston plugs for the $5/8$ -inch through $1\frac{1}{4}$ -inch diameter threaded steel rods and No. 5 through No. 10 steel reinforcing bars, installed in the specified hole diameter, and attached to the mixing nozzle and extension tube supplied by DEWALT as described in [Figure 4](#) in this report. Upwardly inclined and horizontal orientation installation for the $3/8$ -inch and $1/2$ -inch diameter threaded steel rods, and No. 3 and No. 4 steel reinforcing bars may be injected directly to the end of the hole using a mixing nozzle with a hole depth $h_0 \leq 10$ inches (250 mm).

Installation of anchors in horizontal or upwardly inclined orientations shall be fully restrained from movement throughout the specified curing period through the use of temporary wedges, external supports, or other methods. Where temporary restraint devices are used, their use shall not result in impairment of the anchor shear resistance.

4.4 Special Inspection:

Periodic special inspection must be performed where required in accordance with Section 1705.1.1 and Table 1705.3 of the 2024 IBC and this report. The special inspector must be on the jobsite initially during anchor installation to verify the anchor type, anchor dimensions, concrete type, concrete compressive strength, adhesive identification and expiration date, hole dimensions, hole cleaning procedures, anchor spacing, edge distances, concrete thickness, anchor embedment, tightening torque and adherence to the manufacturer's printed installation instructions (MPII). The special inspector must verify the initial installations of each type and size of adhesive anchor by construction personnel on site. Subsequent installations of the same anchor type and size by the same construction personnel are permitted to be performed in the absence of the special inspector. Any change in the anchor product being installed or the personnel performing the installation requires an initial inspection. For ongoing installations over an extended period, the special inspector must make regular inspections to confirm correct handling and installation of the product.

Continuous special inspection of adhesive anchors installed in horizontal or upwardly inclined orientations to resist sustained tension loads shall be performed in accordance with ACI 318-19 Section 26.13.3.2(e).

Under the IBC, additional requirements as set forth in Sections 1705, 1706 or 1707 must be observed, where applicable.

4.5 Compliance with NSF/ANSI Standard 61:

The AC100+ Gold Adhesive Anchor System complies with the requirements of NSF/ANSI Standard 61, as referenced in Section 605 of the 2024 *International Plumbing Code*[®] (IPC), and is certified for use as an anchoring adhesive for installing threaded rods less than or equal to 1.3 inches (33 mm) in diameter in concrete for water treatment applications. An NSF/ANSI Standard 61 listing is provided by NSF International.

5.0 CONDITIONS OF USE:

The AC100+ Gold Adhesive Anchor System described in this report complies with or is a suitable alternative to what is specified in the codes listed in Section 1.0 of this report, subject to the following conditions:

- 5.1 The AC100+ Gold adhesive anchors must be installed in accordance with this report and the manufacturer's printed installation instructions (MPII) as included with each cartridge and described in [Figure 4](#) of this report.
- 5.2 The anchors described in this report must be installed in cracked or uncracked normal-weight concrete or lightweight concrete having a specified compressive strength, $f'_c = 2,500$ psi to 8,500 psi (17.2 MPa to 58.6 MPa).
- 5.3 The values of f'_c used for calculation purposes must not exceed 8,000 psi (55 MPa).
- 5.4 The concrete shall have attained its minimum design strength prior to installation of the anchors.
- 5.5 Anchors must be installed in concrete base materials in holes predrilled in accordance with the instructions provided in [Figure 4](#) of this report.
- 5.6 Loads applied to the anchors must be adjusted in accordance with Section 1605.1 of the 2024 IBC for strength design and for allowable stress design.
- 5.7 The AC100+ Gold adhesive anchors are recognized for use to resist short- and long-term loads, including wind and earthquake, subject to the conditions of this report.
- 5.8 In structures assigned to Seismic Design Categories C, D, E, and F under the IBC or IRC, anchor strength must be adjusted in accordance with Section 4.1.10 of this report.
- 5.9 The AC100+ Gold Adhesive Anchor System is permitted to be installed in concrete that is cracked or that may be expected to crack during the service life of the anchor, subject to the conditions of this report.
- 5.10 Strength design values are established in accordance with Section 4.1 of this report.
- 5.11 Allowable stress design values are established in accordance with Section 4.2 of this report.
- 5.12 Minimum anchor spacing and edge distance, as well as minimum member thickness, must comply with the values described in this report.
- 5.13 Prior to installation, calculations and details demonstrating compliance with this report must be submitted to the code official. The calculations and details must be prepared by a registered design professional where required by the statutes of the jurisdiction in which the project is to be constructed.
- 5.14 Anchors are not permitted to support fire-resistive construction. Where not otherwise prohibited by the code, AC100+ Gold adhesive anchors are permitted for installation in fire-resistive construction provided that at least one of the following conditions is fulfilled:
 - Anchors are used to resist wind or seismic forces only.
 - Anchors that support gravity load-bearing structural elements are within a fire-resistive envelope or a fire-resistive membrane, are protected by approved fire-resistive materials, or have been evaluated for resistance to fire exposure in accordance with recognized standards.
 - Anchors are used to support nonstructural elements.
- 5.15 Since an ICC-ES acceptance criteria for evaluating data to determine the performance of adhesive anchors subjected to fatigue or shock loading is unavailable at this time, the use of these anchors under such conditions is beyond the scope of this report.
- 5.16 Use of zinc-plated carbon steel threaded rods or steel reinforcing bars is limited to dry, interior locations.
- 5.17 Use of hot-dipped galvanized carbon steel and stainless steel rods is permitted for exterior exposure or damp environments.

- 5.18** Steel anchoring materials in contact with preservative-treated wood and fire-retardant-treated wood must be of zinc-coated carbon steel or stainless steel. The minimum coating weights for zinc-coated steel must comply with ASTM A153.
- 5.19** Periodic special inspection must be provided in accordance with Section 4.4 in this report. Continuous special inspection for anchors installed in horizontal or upwardly inclined orientations to resist sustained tension loads must be provided in accordance with Section 4.4 of this report.
- 5.20** Installation of anchors in horizontal or upwardly inclined orientations to resist sustained tension loads shall be performed by personnel certified by an applicable certification program in accordance with ACI 318-19 Sections 26.7.1(l) and 26.7.2(e).
- 5.21** Anchors shall not be used for installations where the in-service concrete temperature can vary from 40°F (5°C) or less to 80°F (27°C) or higher within a 12-hour period. Such applications may include but are not limited to anchorage of building facade systems and other applications subject to direct sun exposure.
- 5.22** AC100+ Gold adhesive is manufactured, under a quality-control program with inspections by ICC-ES.

6.0 EVIDENCE SUBMITTED

Data in accordance with the [ICC-ES Acceptance Criteria for Post-installed Adhesive Anchors and Reinforcing Bars in Concrete Elements \(AC308\)](#), dated February 2023 (editorially revised February 2024), which incorporates requirements in ACI 355.4-19 and ACI 355.4-11 for use in cracked and uncracked concrete; including, but not limited to, tests under freeze/thaw conditions, tests under sustained load, tests for installation direction, tests at elevated temperatures, tests for resistance to alkalinity, tests for resistance to sulfur and tests for seismic tension and shear.

7.0 IDENTIFICATION

- 7.1** The ICC-ES mark of conformity, electronic labeling, or the evaluation report number (ICC-ES ESR-2582) along with the name, registered trademark, or registered logo of the report holder must be included in the product label
- 7.2** In addition, AC100+ Gold adhesive and additional listee product name described in Section 3.1 of this report are identified by packaging labelled with the lot number; expiration date; and company name (DEWALT). Steel anchor elements including threaded rods, nuts, washers, and deformed reinforcing bars must conform to applicable national specifications as set forth in Section 3.2.4 and [Tables 2](#) and [3](#) of this evaluation report or equivalent.
- 7.3** The report holder's contact information is the following:

DEWALT
701 EAST JOPPA ROAD
TOWSON, MARYLAND 21286
(800) 524-3244
www.DEWALT.com
anchors@DEWALT.com

TABLE 1—DESIGN USE AND TABLE INDEX

DESIGN STRENGTH ¹		THREADED ROD (FRACTIONAL) ⁵		DEFORMED REINFORCING BAR ⁵	
Steel	N_{sa}, V_{sa}	Table 4		Table 5	
Concrete	$N_{cb}, N_{cbg}, V_{cb}, V_{cbg}, V_{cp}, V_{cpg}$	Table 6		Table 6	
Bond ²	N_b, N_{bg}	Table 7		Table 8	

CONCRETE TYPE	CONCRETE STATE	THREADED ROD DIAMETER (inch)	REINFORCING BAR SIZE (No.)	DRILLING METHOD ⁴	MINIMUM EMBEDMENT	MAXIMUM EMBEDMENT	SEISMIC DESIGN CATEGORIES ³
Normal-weight and lightweight	Cracked	1/2, 5/8, 3/4, 7/8, 1 and 1 1/4	4, 5, 6, 7, 8, 9, 10	Hammer-drill	See Table 7 and Table 8	See Table 7 and Table 8	A through F
	Uncracked	3/8, 1/2, 5/8, 3/4, 7/8, 1 and 1 1/4	3, 4, 5, 6, 7, 8, 9, 10	Hammer-drill	See Table 7 and Table 8	See Table 7 and Table 8	A and B

For **SI**: 1 inch = 25.4 mm. For **pound-inch** units: 1 mm = 0.03937 inch.

¹Reference ACI 318-19 Section 17.5.1. The controlling strength is decisive from all appropriate failure modes (i.e. steel, concrete, bond) and design assumptions.

²See Section 4.1.4 of this report for bond strength determination of post-installed adhesive anchors.

³See Section 4.1.11 for requirements for seismic design where applicable.

⁴Hammer-drill, i.e. rotary impact drills or rock drills with a carbide bit (including hollow drill bits).

⁵Anchors with 1/2-, 5/8-, 3/4-, 7/8- 1- and 1 1/4-inch-diameter (12.7, 15.9, 19.1, 22.2, 25.4 and 31.8 mm) threaded steel rods and No. 4 through No. 10 steel reinforcing bars may be installed in normal-weight concrete that is cracked or that may be expected to crack during the service life of the anchor. Anchors with 3/8-inch-diameter (9.5 mm) threaded steel rods and No. 3 steel reinforcing bars are limited to installation in uncracked concrete.

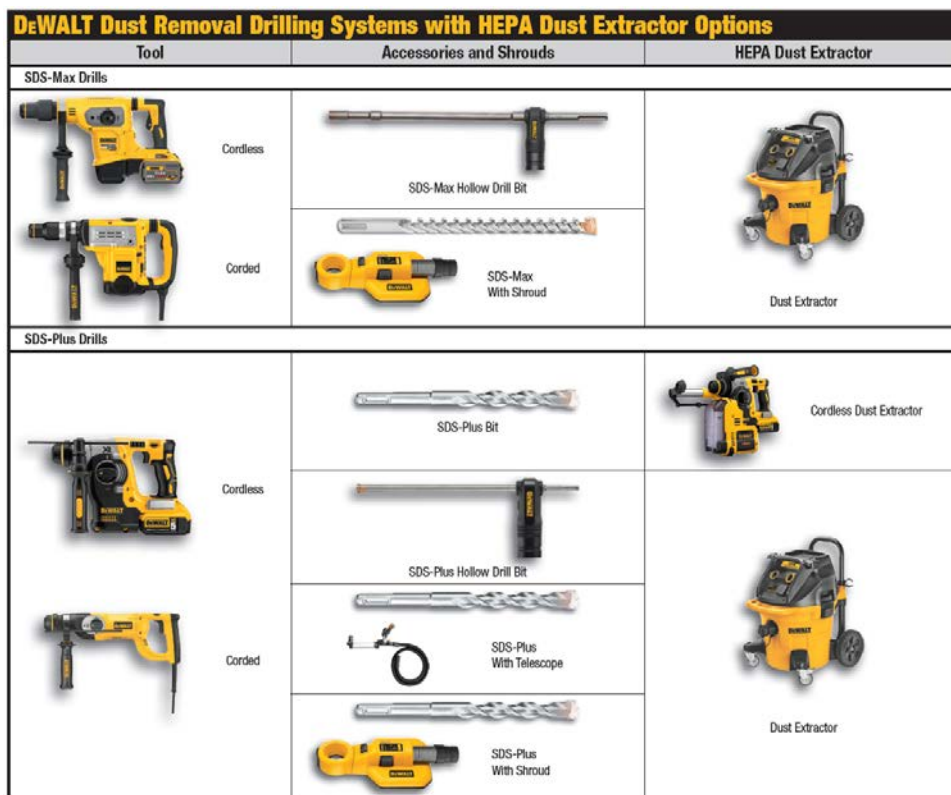

The DEWALT drilling systems shown below collect and remove dust with a HEPA dust extractor during the hole drilling operation in dry base materials using hammer-drills (see step 1 of the manufacturer's published installation instructions).

FIGURE 1—EXAMPLES DEWALT DUST REMOVAL DRILLING SYSTEMS WITH HEPA DUST EXTRACTORS FOR ILLUSTRATION

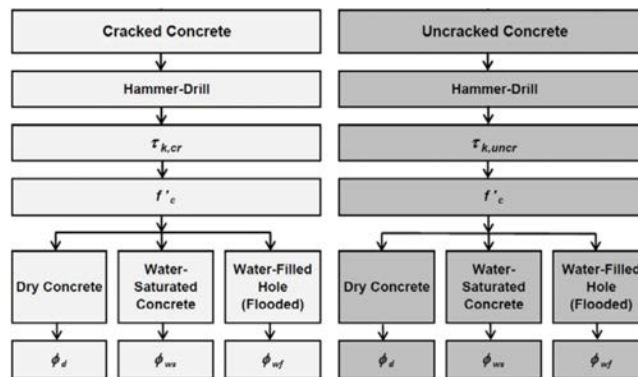

FIGURE 2—FLOW CHART FOR THE ESTABLISHMENT OF DESIGN BOND STRENGTH

TABLE 2—SPECIFICATIONS AND PHYSICAL PROPERTIES OF COMMON FRACTIONAL THREADED CARBON AND STAINLESS STEEL ROD MATERIALS¹

THREADED ROD SPECIFICATION		UNITS	MIN. SPECIFIED ULTIMATE STRENGTH, f_{uta}	MIN. SPECIFIED YIELD STRENGTH 0.2 PERCENT OFFSET, f_{ya}	f_{uta} / f_{ya}	ELONGATION MINIMUM PERCENT ⁸	REDUCTION OF AREA MINIMUM PERCENT	NUT SPECIFICATION ⁹
Carbon Steel	ASTM A36 ² and F1554 ³ Grade 36	psi (MPa)	58,000 (400)	36,000 (248)	1.61	23	40 ¹⁰	ASTM A194 / A563 Grade A
	ASTM F1554 ³ Grade 55	psi (MPa)	75,000 (517)	55,000 (380)	1.36	23	40	
	ASTM F1554 ³ Grade 105	psi (MPa)	125,000 (862)	105,000 (724)	1.19	15	45	ASTM A194 / A563 Grade D
	ASTM A193 ⁴ Grade B7	psi (MPa)	125,000 (860)	105,000 (720)	1.19	16	50	
	ASTM A449 ⁵ (3/8 to 1 inch dia.)	psi (MPa)	120,000 (828)	92,000 (635)	1.30	14	35	ASTM A194 / A563 Grade DH
	ASTM A449 ⁵ (1 1/4 inch dia.)	psi (MPa)	105,000 (720)	81,000 (559)	1.30	14	35	
Stainless Steel (Types 304 and 316)	ASTM F593 ⁶ CW1 (3/8 to 5/8 inch dia.)	psi (MPa)	100,000 (690)	65,000 (450)	1.54	20	.11	ASTM F594 Alloy Group 1, 2 or 3
	ASTM F593 ⁶ CW2 (3/4 to 1 1/4 inch dia.)	psi (MPa)	85,000 (590)	45,000 (310)	1.89	25	.11	
	ASTM A193 ⁷ Grade B8/B8M, Class 1	psi (MPa)	75,000 (517)	30,000 (207)	2.50	30	50	ASTM F594 Alloy Group 1, 2 or 3
	ASTM A193 ⁷ Grade B8/B8M2, Class 2B	psi (MPa)	95,000 (655)	75,000 (517)	1.27	25	40	

For **SI**: 1 inch = 25.4 mm, 1 psi = 0.006897 MPa. For **pound-inch** units: 1 mm = 0.03937 inch, 1 MPa = 145.0 psi.

¹Adhesive must be used with continuously threaded carbon or stainless steels (all-thread) that have thread characteristics comparable with ANSI B1.1 UNC Coarse Thread Series. Tabulated values correspond to anchor diameters included in this report. See Section 3.2.4.3 of this report for ductility of steel anchor elements.

²Standard Specification for Carbon Structural Steel.

³Standard Specification for Anchor Bolts, Steel, 36, 55, and 105-ksi Yield Strength.

⁴Standard Specification for Alloy-Steel and Stainless Steel Bolting Materials for High Temperature or High Pressure Service and Other Special Purpose Applications.

⁵Standard Specification for Hex Cap Screws, Bolts and Studs, Steel, Heat Treated, 120/105/90 ksi Minimum Tensile Strength, General Use.

⁶Standard Specification for Stainless Steel Bolts, Hex Cap Screws, and Studs.

⁷Standard Specification for Alloy-Steel and Stainless Steel Bolting for High Temperature or High Pressure Service and Other Special Purpose Applications.

⁸Based on 2-inch (50 mm) gauge length except ASTM A193, which are based on a gauge length of 4d.

⁹Nuts of other grades and style having specified proof load stress greater than the specified grade and style are also suitable. Nuts must have specified proof load stresses equal to or greater than the minimum tensile strength of the specified threaded rod. Material types of the nuts and washers must be matched to the threaded rods.

¹⁰Minimum percent reduction of area reported in ASTM A36 is 50 percent.

¹¹Minimum percent reduction of area not reported in the referenced ASTM standard.

TABLE 3—SPECIFICATIONS AND PHYSICAL PROPERTIES OF COMMON STEEL REINFORCING BARS¹

REINFORCING SPECIFICATION	UNITS	MINIMUM SPECIFIED ULTIMATE STRENGTH, f_{uta}	MINIMUM SPECIFIED YIELD STRENGTH, f_{ya}
ASTM A615 ² , A767 ⁴ , Grade 80	psi (MPa)	100,000 (690)	80,000 (550)
ASTM A615 ² , A767 ⁴ , Grade 75	psi (MPa)	100,000 (690)	75,000 (520)
ASTM A615 ² , A767 ⁴ , Grade 60	psi (MPa)	80,000 (550)	60,000 (414)
ASTM A706 ³ , A767 ⁴ , Grade 60	psi (MPa)	80,000 (550)	60,000 (414)
ASTM A615 ² , A767 ⁴ , Grade 40	psi (MPa)	60,000 (415)	40,000 (275)

For **SI**: 1 psi = 0.006897 MPa. For **pound-inch** units: 1 MPa = 145.0 psi.

¹Adhesive must be used with specified deformed reinforcing bars. Tabulated values correspond to bar sizes included in this report.

²Standard Specification for Deformed and Plain Carbon-Steel Bars for Concrete Reinforcement. Grade 60 and Grade 40 bars may be considered ductile elements. In accordance with ACI 318-19 Section 17.10.5.3(a)(vi), deformed reinforcing bars meeting this specification used as ductile steel elements to resist earthquake effects shall be limited to reinforcing bars satisfying the requirements of ACI 318-19 Sections 20.2.2.4 and 20.2.2.5. Grade 75 bars furnished to specification are considered brittle elements unless evidence is otherwise shown to the satisfaction of the registered design professional and code official in accordance with Section 3.2.4.3 of this report.

³Standard Specification for Low-Alloy Steel Deformed and Plain Bars for Concrete Reinforcement. Bars furnished to specification are considered ductile elements.

⁴Standard Specification for Zinc-Coated (Galvanized) Steel Bars for Concrete Reinforcement. Bars furnished to specification are considered brittle elements unless evidence is otherwise shown to the satisfaction of the registered design professional and code official in accordance with Section 3.2.4.3 of this report.

TABLE 4—STEEL DESIGN INFORMATION FOR FRACTIONAL THREADED ROD

DESIGN INFORMATION		SYMBOL	UNITS	NOMINAL ROD DIAMETER (inch) ¹						
				3/8	1/2	5/8	3/4	7/8	1	1 1/4
Threaded rod nominal outside diameter		<i>d</i>	inch (mm)	0.375 (9.5)	0.500 (12.7)	0.625 (15.9)	0.750 (19.1)	0.875 (22.2)	1.000 (25.4)	1.250 (31.8)
Threaded rod effective cross-sectional area		<i>A_{se}</i>	inch ² (mm ²)	0.0775 (50)	0.1419 (92)	0.2260 (146)	0.3345 (216)	0.4617 (298)	0.6057 (391)	0.9691 (625)
ASTM A36 and F1554, Grade 36	Nominal strength as governed by steel strength (for a single anchor)	<i>N_{sa}</i>	lbf (kN)	4,495 (20.0)	8,230 (36.6)	13,110 (58.3)	19,400 (86.3)	26,780 (119.1)	35,130 (156.3)	56,210 (250.0)
		<i>V_{sa}</i>	lbf (kN)	2,695 (12.0)	4,940 (22.0)	7,860 (35.0)	11,640 (51.8)	16,070 (71.4)	21,080 (93.8)	33,725 (150.0)
	Reduction factor for seismic shear	$\alpha_{V,seis}$	-	Not applicable	0.85	0.85	0.85	0.85	0.85	0.80
	Strength reduction factor for tension ²	ϕ	-	0.75						
	Strength reduction factor for shear ²	ϕ	-	0.65						
ASTM F1554, Grade 55	Nominal strength as governed by steel strength (for a single anchor)	<i>N_{sa}</i>	lbf (kN)	5,810 (25.9)	10,640 (47.3)	16,950 (75.4)	25,085 (111.6)	34,625 (154.0)	45,425 (202.0)	72,680 (323.3)
		<i>V_{sa}</i>	lbf (kN)	3,485 (15.5)	6,385 (28.4)	10,170 (45.2)	15,050 (67.0)	20,775 (92.4)	27,255 (121.2)	43,610 (194.0)
	Reduction factor for seismic shear	$\alpha_{V,seis}$	-	Not applicable	0.85	0.85	0.85	0.85	0.85	0.80
	Strength reduction factor for tension ²	ϕ	-	0.75						
	Strength reduction factor for shear ²	ϕ	-	0.65						
ASTM A193 Grade B7 and F1554, Grade 105	Nominal strength as governed by steel strength (for a single anchor)	<i>N_{sa}</i>	lbf (kN)	9,685 (43.1)	17,735 (78.9)	28,250 (125.7)	41,810 (186.0)	57,710 (256.7)	75,710 (336.8)	121,135 (538.8)
		<i>V_{sa}</i>	lbf (kN)	5,815 (25.9)	10,640 (47.3)	16,950 (75.4)	25,085 (111.6)	34,625 (154.0)	45,425 (202.1)	72,680 (323.3)
	Reduction factor for seismic shear	$\alpha_{V,seis}$	-	Not applicable	0.85	0.85	0.85	0.85	0.85	0.80
	Strength reduction factor for tension ²	ϕ	-	0.75						
	Strength reduction factor for shear ²	ϕ	-	0.65						
ASTM A449	Nominal strength as governed by steel strength (for a single anchor)	<i>N_{sa}</i>	lbf (kN)	9,300 (41.4)	17,025 (75.7)	27,120 (120.6)	40,140 (178.5)	55,905 (248.7)	63,600 (282.9)	101,755 (452.6)
		<i>V_{sa}</i>	lbf (kN)	5,580 (24.8)	10,215 (45.4)	16,270 (72.4)	24,085 (107.1)	33,540 (149.2)	38,160 (169.7)	61,050 (271.6)
	Reduction factor for seismic shear	$\alpha_{V,seis}$	-	Not applicable	0.80	0.80	0.80	0.80	0.80	0.80
	Strength reduction factor for tension ²	ϕ	-	0.75						
	Strength reduction factor for shear ²	ϕ	-	0.65						
ASTM F593 CW Stainless (Types 304 and 316)	Nominal strength as governed by steel strength (for a single anchor)	<i>N_{sa}</i>	lbf (kN)	7,750 (34.5)	14,190 (63.1)	22,600 (100.5)	28,430 (126.5)	39,245 (174.6)	51,485 (229.0)	82,370 (366.4)
		<i>V_{sa}</i>	lbf (kN)	4,650 (20.7)	8,515 (37.9)	13,560 (60.3)	17,060 (75.9)	23,545 (104.7)	30,890 (137.4)	49,425 (219.8)
	Reduction factor for seismic shear	$\alpha_{V,seis}$	-	Not applicable	0.85	0.85	0.85	0.85	0.85	0.80
	Strength reduction factor for tension ²	ϕ	-	0.65						
	Strength reduction factor for shear ²	ϕ	-	0.60						
ASTM A193 Grade B8/B8M, Class 1 Stainless (Types 304 and 316)	Nominal strength as governed by steel strength (for a single anchor) ³	<i>N_{sa}</i>	lbf (kN)	4,420 (19.7)	8,090 (36.0)	12,880 (57.3)	19,065 (84.8)	26,315 (117.1)	34,525 (153.6)	55,240 (245.7)
		<i>V_{sa}</i>	lbf (kN)	2,650 (11.8)	4,855 (21.6)	7,730 (34.4)	11,440 (50.9)	15,790 (70.2)	20,715 (92.1)	33,145 (147.4)
	Reduction factor for seismic shear	$\alpha_{V,seis}$	-	Not applicable	0.85	0.85	0.85	0.85	0.85	0.80
	Strength reduction factor for tension ²	ϕ	-	0.75						
	Strength reduction factor for shear ²	ϕ	-	0.65						
ASTM A193 Grade B8/B8M2, Class 2B Stainless (Types 304 and 316)	Nominal strength as governed by steel strength (for a single anchor)	<i>N_{sa}</i>	lbf (kN)	7,365 (32.8)	13,480 (60.0)	21,470 (95.5)	31,775 (141.3)	43,860 (195.1)	57,545 (256.0)	92,065 (409.5)
		<i>V_{sa}</i>	lbf (kN)	4,470 (19.7)	8,085 (36.0)	12,880 (57.3)	19,065 (84.8)	26,315 (117.1)	34,525 (153.6)	55,240 (245.7)
	Reduction factor for seismic shear	$\alpha_{V,seis}$	-	Not applicable	0.85	0.85	0.85	0.85	0.85	0.80
	Strength reduction factor for tension ²	ϕ	-	0.75						
	Strength reduction factor for shear ²	ϕ	-	0.65						

For **SI**: 1 inch = 25.4 mm, 1 lbf = 4.448 N. For **pound-inch** units: 1 mm = 0.03937 inches, 1 N = 0.2248 lbf.

¹Values provided for steel element material types based on minimum specified strengths and calculated in accordance with ACI 318-19 Eq. 17.6.1.2 and Eq. 17.7.1.2(b). Nuts must be appropriate for the rod, as listed in Table 2 of this report.

²The strength reduction factor applies when the load combinations from the IBC or ACI 318-19 are used and the requirements of ACI 318-19 Section 17.5.3 are met.

³In accordance with ACI 318-19 Eq. 17.6.1.2 and Eq. 17.7.1.2(b), the calculated values for nominal tension and shear strength for ASTM A193 Grade B8/B8M Class 1 stainless steel threaded rods are based on limiting the specified tensile strength of the anchor steel to 1.9 f_y or 57,000 psi (393 MPa).

TABLE 5—STEEL DESIGN INFORMATION FOR REINFORCING BARS

DESIGN INFORMATION		SYMBOL	UNITS	NOMINAL REINFORCING BAR SIZE (REBAR) ¹									
				No. 3	No. 4	No. 5	No. 6	No. 7	No. 8	No. 9	No. 10		
Rebar nominal outside diameter		<i>d</i>	inch (mm)	0.375 (9.5)	0.500 (12.7)	0.625 (15.9)	0.750 (19.1)	0.875 (22.2)	1.000 (25.4)	1.125 (28.7)	1.250 (32.3)		
Rebar effective cross-sectional area		<i>A_{se}</i>	inch ² (mm ²)	0.110 (71)	0.200 (129)	0.310 (200)	0.440 (284)	0.600 (387)	0.790 (510)	1.000 (645)	1.270 (819)		
ASTM A615, Grade 80	Nominal strength as governed by steel strength (for a single anchor)	<i>N_{sa}</i>	lbf (kN)	11,000 (48.9)	20,000 (89.0)	31,000 (137.9)	44,000 (195.7)	60,000 (266.9)	79,000 (351.4)	100,000 (444.8)	127,000 (564.9)		
		<i>V_{sa}</i>	lbf (kN)	6,600 (29.4)	12,000 (53.4)	18,600 (82.7)	26,400 (117.4)	36,000 (160.1)	47,400 (210.8)	60,000 (266.9)	76,200 (338.9)		
	Reduction factor for seismic shear	$\alpha_{V,seis}$	-	Not applicable									
	Strength reduction factor for tension ²	ϕ	-	0.65									
	Strength reduction factor for shear ²	ϕ	-	0.60									
ASTM A615, Grade 75	Nominal strength as governed by steel strength (for a single anchor)	<i>N_{sa}</i>	lbf (kN)	11,000 (48.9)	20,000 (89.0)	31,000 (137.9)	44,000 (195.7)	60,000 (266.9)	79,000 (351.4)	100,000 (444.8)	127,000 (564.9)		
		<i>V_{sa}</i>	lbf (kN)	6,600 (29.4)	12,000 (53.4)	18,600 (82.7)	26,400 (117.4)	36,000 (160.1)	47,400 (210.8)	60,000 (266.9)	76,200 (338.9)		
	Reduction factor for seismic shear	$\alpha_{V,seis}$	-	Not applicable									
	Strength reduction factor for tension ²	ϕ	-	0.65									
	Strength reduction factor for shear ²	ϕ	-	0.60									
ASTM A615, Grade 60	Nominal strength as governed by steel strength (for a single anchor)	<i>N_{sa}</i>	lbf (kN)	8,800 (39.1)	16,000 (71.2)	24,800 (110.3)	35,200 (156.6)	48,000 (213.5)	63,200 (281.1)	80,000 (355.9)	101,600 (452.0)		
		<i>V_{sa}</i>	lbf (kN)	5,280 (23.5)	9,600 (42.7)	14,880 (66.2)	21,120 (94.0)	28,800 (128.1)	37,920 (168.7)	48,000 (213.5)	60,960 (271.2)		
	Reduction factor for seismic shear	$\alpha_{V,seis}$	-	Not applicable									
	Strength reduction factor for tension ²	ϕ	-	0.65									
	Strength reduction factor for shear ²	ϕ	-	0.60									
ASTM A706, Grade 60	Nominal strength as governed by steel strength (for a single anchor)	<i>N_{sa}</i>	lbf (kN)	8,800 (39.1)	16,000 (71.2)	24,800 (110.3)	35,200 (156.6)	48,000 (213.5)	63,200 (281.1)	80,000 (355.9)	101,600 (452.0)		
		<i>V_{sa}</i>	lbf (kN)	5,280 (23.5)	9,600 (42.7)	14,880 (66.2)	21,120 (94.0)	28,800 (128.1)	37,920 (168.7)	48,000 (213.5)	60,960 (271.2)		
	Reduction factor for seismic shear	$\alpha_{V,seis}$	-	Not applicable									
	Strength reduction factor for tension ²	ϕ	-	0.75									
	Strength reduction factor for shear ²	ϕ	-	0.65									
ASTM A615, Grade 40	Nominal strength as governed by steel strength (for a single anchor)	<i>N_{sa}</i>	lbf (kN)	6,600 (29.4)	12,000 (53.4)	18,600 (82.7)	26,400 (117.4)	In accordance with ASTM A615, Grade 40 bars are furnished only in sizes No. 3 through No. 6					
		<i>V_{sa}</i>	lbf (kN)	3,960 (17.6)	7,200 (32.0)	11,160 (49.6)	15,840 (70.5)						
	Reduction factor for seismic shear	$\alpha_{V,seis}$	-	Not applicable			0.70					0.70	0.70
	Strength reduction factor for tension ²	ϕ	-	0.65									
	Strength reduction factor for shear ²	ϕ	-	0.60									

For **SI**: 1 inch = 25.4 mm, 1 lbf = 4.448 N. For **pound-inch** units: 1 mm = 0.03937 inches, 1 N = 0.2248 lbf.

¹Values provided for reinforcing bar material types based on minimum specified strengths and calculated in accordance with ACI 318-19 Eq. 17.6.1.2 and Eq. 17.7.1.2(b).

²The strength reduction factor applies when the load combinations from the IBC or ACI 318-19 are used and the requirements of ACI 318-19 Section 17.5.3 are met.

TABLE 6—CONCRETE BREAKOUT AND PRYOUT DESIGN INFORMATION FOR FRACTIONAL THREADED ROD AND REINFORCING BARS IN HOLES DRILLED WITH A HAMMER DRILL AND CARBIDE BIT¹

DESIGN INFORMATION	SYMBOL	UNITS	NOMINAL ROD DIAMETER (inch) / REINFORCING BAR SIZE							
			3/8 or #3	1/2 or #4	5/8 or #5	3/4 or #6	7/8 or #7	1 or #8	#9	1 1/4 or #10
Effectiveness factor for cracked concrete	$k_{c,cr}$	- (SI)	Not Applicable	17 (7.1)						
Effectiveness factor for uncracked concrete	$k_{c,uncr}$	- (SI)	24 (10.0)							
Minimum embedment	$h_{ef,min}$	inch (mm)	2 3/8 (60)	2 3/4 (70)	3 1/8 (79)	3 1/2 (89)	3 1/2 (89)	4 (102)	4 1/2 (114)	5 (127)
Maximum embedment	$h_{ef,max}$	inch (mm)	4 1/2 (114)	6 (152)	7 1/2 (191)	9 (229)	10 1/2 (267)	12 (305)	13 1/2 (343)	15 (381)
Minimum anchor spacing	s_{min}	inch (mm)	1 7/8 (48)	2 1/2 (64)	3 1/8 (79)	3 3/4 (95)	4 3/8 (111)	5 (127)	5 5/8 (143)	6 1/4 (159)
Minimum edge distance	c_{min}	inch (mm)	5d where d is nominal outside diameter of the anchor; see Section 4.1.9 of this report for design with reduced minimum edge distances (with reduced torque)							
Minimum member thickness	h_{min}	inch (mm)	$h_{ef} + 1 1/4$ ($h_{ef} + 30$)		$h_{ef} + 2d_o$ where d_o is hole diameter; for installation parameters see Table 9 of this report					
Critical edge distance—splitting (for uncracked concrete only)	c_{ac}	inch (mm)	See Section 4.1.10 of this report							
Strength reduction factor for tension, concrete failure modes, Condition B ²	ϕ	-	0.65							
Strength reduction factor for shear, concrete failure modes, Condition B ²	ϕ	-	0.70							

For **SI**: 1 inch = 25.4 mm, 1 lbf = 4.448 N. For **pound-inch** units: 1 mm = 0.03937 inch, 1 N = 0.2248 lbf.

¹Additional setting information is described in the installation instructions, [Figure 4](#) of this report.

²The strength reduction factor applies when the load combinations from the IBC or ACI 318-19 are used and the requirements of ACI 318-19 Section 17.5.3 are met.

TABLE 7—BOND STRENGTH DESIGN INFORMATION FOR FRACTIONAL THREADED RODS IN HOLES DRILLED WITH A HAMMER DRILL AND CARBIDE BIT¹

DESIGN INFORMATION		SYMBOL	UNITS	NOMINAL ROD DIAMETER (inch)						
				3/8	1/2	5/8	3/4	7/8	1	1 1/4
Minimum embedment		$h_{ef,min}$	inch (mm)	2 3/8 (60)	2 3/4 (70)	3 1/8 (79)	3 1/2 (89)	3 1/2 (89)	4 (102)	5 (127)
Maximum embedment		$h_{ef,max}$	inch (mm)	4 1/2 (114)	6 (152)	7 1/2 (191)	9 (229)	10 1/2 (267)	12 (305)	15 (381)
110°F (43.3°C) Maximum long-term service temperature; 140°F (60°C) maximum short-term service temperature ³	Characteristic bond strength in cracked concrete ^{4,6}	$\tau_{k,cr}$	psi (N/mm ²)	Not applicable	545 (3.8)	568 (3.9)	568 (3.9)	568 (3.9)	575 (4.0)	575 (4.0)
	Characteristic bond strength in cracked concrete, short-term loads only ⁶	$\tau_{k,cr}$	psi (N/mm ²)	Not applicable	779 (5.4)	811 (5.6)	811 (5.6)	811 (5.6)	821 (5.7)	821 (5.7)
	Characteristic bond strength in uncracked concrete ^{4,7}	$\tau_{k,uncr}$	psi (N/mm ²)	902 (6.2)	902 (6.2)	902 (6.2)	902 (6.2)	902 (6.2)	815 (5.6)	645 (4.4)
	Characteristic bond strength in uncracked concrete, short-term loads only ⁷	$\tau_{k,uncr}$	psi (N/mm ²)	1,288 (8.9)	1,288 (8.9)	1,288 (8.9)	1,288 (8.9)	1,288 (8.9)	1,164 (8.0)	921 (6.4)
122°F (50°C) Maximum long-term service temperature; 176°F (80°C) maximum short-term service temperature ^{2,3}	Characteristic bond strength in cracked concrete ^{4,6}	$\tau_{k,cr}$	psi (N/mm ²)	Not applicable	498 (3.4)	519 (3.6)	519 (3.6)	519 (3.6)	519 (3.6)	525 (3.6)
	Characteristic bond strength in cracked concrete, short-term loads only ⁶	$\tau_{k,cr}$	psi (N/mm ²)	Not applicable	712 (4.9)	742 (5.1)	742 (5.1)	742 (5.1)	742 (5.1)	751 (5.2)
	Characteristic bond strength in uncracked concrete ^{4,7}	$\tau_{k,uncr}$	psi (N/mm ²)	823 (5.7)	823 (5.7)	823 (5.7)	823 (5.7)	823 (5.7)	743 (5.1)	588 (4.1)
	Characteristic bond strength in uncracked concrete, short-term loads only ⁷	$\tau_{k,uncr}$	psi (N/mm ²)	1,177 (8.1)	1,177 (8.1)	1,177 (8.1)	1,177 (8.1)	1,177 (8.1)	1,062 (7.3)	841 (5.8)
162°F (72°C) Maximum long-term service temperature; 248°F (120°C) maximum short-term service temperature ^{2,3}	Characteristic bond strength in cracked concrete ^{4,6}	$\tau_{k,cr}$	psi (N/mm ²)	Not applicable	245 (1.7)	255 (1.8)	255 (1.8)	255 (1.8)	255 (1.8)	255 (1.8)
	Characteristic bond strength in cracked concrete, short-term loads only ⁶	$\tau_{k,cr}$	psi (N/mm ²)	Not applicable	544 (3.7)	566 (3.9)	566 (3.9)	566 (3.9)	566 (3.9)	566 (3.9)
	Characteristic bond strength in uncracked concrete ^{4,7}	$\tau_{k,uncr}$	psi (N/mm ²)	405 (2.8)	405 (2.8)	405 (2.8)	405 (2.8)	405 (2.8)	366 (2.5)	Not applicable
	Characteristic bond strength in uncracked concrete, short term loads only ⁷	$\tau_{k,uncr}$	psi (N/mm ²)	899 (6.2)	899 (6.2)	899 (6.2)	899 (6.2)	899 (6.2)	813 (5.6)	Not applicable
Permissible installation conditions ⁵	Dry concrete	ϕ_d	-	0.65				0.65	0.65	0.65
	Water-saturated concrete	ϕ_{ws}	-	0.65				0.55	0.55	0.55
	Water-filled hole (flooded)	ϕ_{wf}	-	0.45				0.45	0.45	0.45
		k_{wf}	-	0.78				0.70	0.69	0.67
Reduction factor for seismic tension		$\alpha_{N,seis}$	-	0.95						

For **SI**: 1 inch = 25.4 mm, 1 psi = 0.006894 MPa. For **pound-inch** units: 1 mm = 0.03937 inch, 1 MPa = 145.0 psi.

¹Bond strength values correspond to concrete compressive strength $f'_c = 2,500$ psi. For concrete compressive strength, f'_c between 2,500 psi and 8,000 psi, the tabulated characteristic bond strength may be increased by a factor of $(f'_c / 2,500)^{0.13}$ [For **SI**: $(f'_c / 17.2)^{0.13}$]. See Section 4.1.4 of this report.

²Long-term and short-term temperatures meet and exceed the requirements of Section 8.5 of ACI 355.4 and Table 9.1, Temperature Category A.

³Short-term elevated concrete temperatures are those that occur over brief intervals, e.g. as a result of diurnal cycling. Long-term concrete temperatures are roughly constant over significant periods of time.

⁴Characteristic bond strengths are for sustained loads including dead and live loads.

⁵Permissible installation conditions include dry concrete, water-saturated concrete and water-filled holes. Water-filled holes include applications in dry or water-saturated concrete where the drilled holes contain standing water during anchor installation. For installation instructions see [Figure 4](#) of this report.

⁶For structures assigned to Seismic Design Categories C, D, E or F, bond strength values for cracked concrete must be adjusted by an additional reduction factor, $\alpha_{N,seis}$, as given in the table. See Section 4.1.10 of this report.

⁷Bond strength values for uncracked concrete are applicable for structures assigned to Seismic Design Categories A and B only.

TABLE 8—BOND STRENGTH DESIGN INFORMATION FOR REINFORCING BARS IN HOLES DRILLED WITH A HAMMER DRILL AND CARBIDE BIT¹

DESIGN INFORMATION		SYMBOL	UNITS	REINFORCING BAR SIZE							
				#3	#4	#5	#6	#7	#8	#9	#10
Minimum embedment		$h_{ef,min}$	inch (mm)	2 ³ / ₈ (60)	2 ³ / ₄ (70)	3 ¹ / ₈ (79)	3 ¹ / ₂ (89)	3 ¹ / ₂ (89)	4 (102)	4 ¹ / ₂ (114)	5 (127)
Maximum embedment		$h_{ef,max}$	inch (mm)	4 ¹ / ₂ (114)	6 (152)	7 ¹ / ₂ (191)	9 (229)	10 ¹ / ₂ (267)	12 (305)	13 ¹ / ₂ (343)	15 (381)
110°F (43.3°C) Maximum long-term service temperature; 140°F (60°C) maximum short-term service temperature ³	Characteristic bond strength in cracked concrete ^{4,6}	$\tau_{k,cr}$	psi (N/mm ²)	Not applicable	361 (2.5)	376 (2.6)	376 (2.6)	376 (2.6)	381 (2.6)	381 (2.6)	381 (2.6)
	Characteristic bond strength in cracked concrete, short-term loads only ⁶	$\tau_{k,cr}$	psi (N/mm ²)	Not applicable	516 (3.6)	538 (3.7)	538 (3.7)	538 (3.7)	544 (3.8)	544 (3.8)	544 (3.8)
	Characteristic bond strength in uncracked concrete ^{4,7}	$\tau_{k,uncr}$	psi (N/mm ²)	902 (6.2)	902 (6.2)	902 (6.2)	902 (6.2)	902 (6.2)	815 (5.6)	732 (5.0)	645 (4.4)
	Characteristic bond strength in uncracked concrete, short-term loads only ⁷	$\tau_{k,uncr}$	psi (N/mm ²)	1,288 (8.9)	1,288 (8.9)	1,288 (8.9)	1,288 (8.9)	1,288 (8.9)	1,164 (8.0)	1,046 (7.2)	921 (6.4)
				Not applicable in water-filled hole installation condition							
				Not applicable in water-filled hole installation condition							
122°F (50°C) Maximum long-term service temperature; 176°F (80°C) maximum short-term service temperature ^{2,3}	Characteristic bond strength in cracked concrete ^{4,6}	$\tau_{k,cr}$	psi (N/mm ²)	Not applicable	331 (2.3)	345 (2.4)	345 (2.4)	345 (2.4)	345 (2.4)	349 (2.4)	349 (2.4)
	Characteristic bond strength in cracked concrete, short-term loads only ⁶	$\tau_{k,cr}$	psi (N/mm ²)	Not applicable	473 (3.3)	493 (3.4)	493 (3.4)	493 (3.4)	493 (3.4)	499 (3.4)	499 (3.4)
	Characteristic bond strength in uncracked concrete ^{4,7}	$\tau_{k,uncr}$	psi (N/mm ²)	823 (5.7)	823 (5.7)	823 (5.7)	823 (5.7)	823 (5.7)	743 (5.1)	655 (4.5)	588 (4.1)
	Characteristic bond strength in uncracked concrete, short-term loads only ⁷	$\tau_{k,uncr}$	psi (N/mm ²)	1,177 (8.1)	1,177 (8.1)	1,177 (8.1)	1,177 (8.1)	1,177 (8.1)	1,062 (7.3)	951 (6.6)	841 (5.8)
				Not applicable in water-filled hole installation condition							
162°F (72°C) Maximum long-term service temperature; 248°F (120°C) maximum short-term service temperature ^{2,3}	Characteristic bond strength in cracked concrete ^{4,6}	$\tau_{k,cr}$	psi (N/mm ²)	Not applicable	163 (1.1)	170 (1.2)	170 (1.2)	170 (1.2)	170 (1.2)	170 (1.2)	170 (1.2)
	Characteristic bond strength in cracked concrete, short-term loads only ⁶	$\tau_{k,cr}$	psi (N/mm ²)	Not applicable	362 (2.5)	377 (2.6)	377 (2.6)	377 (2.6)	377 (2.6)	382 (2.6)	382 (2.6)
	Characteristic bond strength in uncracked concrete ^{4,7}	$\tau_{k,uncr}$	psi (N/mm ²)	405 (2.8)	405 (2.8)	405 (2.8)	405 (2.8)	405 (2.8)	405 (2.8)	366 (2.5)	329 (2.3)
	Characteristic bond strength in uncracked concrete, short-term loads only ⁷	$\tau_{k,uncr}$	psi (N/mm ²)	899 (6.2)	899 (6.2)	899 (6.2)	899 (6.2)	899 (6.2)	899 (6.2)	813 (5.6)	730 (5.0)
				Not applicable in water-filled hole installation condition							
				Not applicable in water-filled hole installation condition							
Permissible installation conditions ⁵	Dry concrete	ϕ_d	-	0.65				0.65	0.65	0.65	0.65
	Water-saturated concrete	ϕ_{ws}	-	0.65				0.55	0.55	0.55	0.55
	Water-filled hole (flooded)	ϕ_{wfl}	-	0.45				0.45	0.45	0.45	0.45
		K_{wfl}	-	0.78				0.70	0.69	0.68	0.67
Reduction factor for seismic tension		$\alpha_{N,seis}$	-	1.0							

For SI: 1 inch = 25.4 mm, 1 psi = 0.006894 MPa. For pound-inch units: 1 mm = 0.03937 inch, 1 MPa = 145.0 psi.

¹Bond strength values correspond to concrete compressive strength $f'_c = 2,500$ psi. For concrete compressive strength, f'_c between 2,500 psi and 8,000 psi, the tabulated characteristic bond strength may be increased by a factor of $(f'_c / 2,500)^{0.13}$ [For SI: $(f'_c / 17.2)^{0.13}$]. See Section 4.1.4 of this report.

²Long-term and short-term temperatures meet and exceed the requirements of Section 8.5 of ACI 355.4 and Table 9.1, Temperature Category A.

³Short-term elevated concrete temperatures are those that occur over brief intervals, e.g. as a result of diurnal cycling. Long-term concrete temperatures are roughly constant over significant periods of time.

⁴Characteristic bond strengths are for sustained loads including dead and live loads.

⁵Permissible installation conditions include dry concrete, water-saturated concrete and water-filled holes. Water-filled holes include applications in dry or water-saturated concrete where the drilled holes contain standing water during anchor installation. For installation instructions see Figure 4 of this report.

⁶For structures assigned to Seismic Design Categories C, D, E or F, the tabulated bond strength values for cracked concrete do not require an additional reduction factor applied for seismic tension ($\alpha_{N,seis} = 1.0$), where seismic design is applicable. See Section 4.1.10 of this report for requirements for seismic design.

⁷Bond strength values for uncracked concrete are applicable for structures assigned to Seismic Design Categories A and B only.

TABLE 9—INSTALLATION PARAMETERS FOR FRACTIONAL THREADED ROD AND REINFORCING BARS

PARAMETER	SYMBOL	UNITS	NOMINAL ROD DIAMETER (inch) / REINFORCING BAR SIZE									
			³ / ₈ or #3	¹ / ₂ #4	⁵ / ₈ or #5	³ / ₄ or #6	⁷ / ₈ or #7	1 or #8	#9	1 ¹ / ₄	#10	
Threaded rod outside diameter	<i>d</i>	inch (mm)	0.375 (9.5)	0.500 (12.7)	0.625 (15.9)	0.750 (19.1)	0.875 (22.2)	1.000 (25.4)	N/A ¹	1.250 (31.8)	N/A ¹	
Rebar nominal outside diameter	<i>d</i>	inch (mm)	0.375 (9.5)	0.500 (12.7)	0.625 (15.9)	0.750 (19.1)	0.875 (22.2)	1.000 (25.4)	1.125 (28.7)	N/A ¹	1.250 (31.8)	
Carbide drill bit nominal size	<i>d_o</i> (<i>d_{bit}</i>)	inch	⁷ / ₁₆	⁹ / ₁₆ ⁵ / ₈	¹¹ / ₁₆ or ³ / ₄	⁷ / ₈	1	1 ¹ / ₈	1 ³ / ₈	1 ³ / ₈	1 ¹ / ₂	
Minimum embedment	<i>h_{ef,min}</i>	inch (mm)	2 ³ / ₈ (60)	2 ³ / ₄ (70)	3 ¹ / ₈ (79)	3 ¹ / ₂ (89)	3 ¹ / ₂ (89)	4 (102)	4 ¹ / ₂ (114)	5 (127)	5 (127)	
Maximum embedment	<i>h_{ef,max}</i>	inch (mm)	4 ¹ / ₂ (114)	6 (152)	7 ¹ / ₂ (191)	9 (229)	10 ¹ / ₂ (267)	12 (305)	13 ¹ / ₂ (343)	15 (381)	15 (381)	
Max. rod torque	<i>T_{max}</i>	ft-lbs	15	33	60	105	125	165	N/A ¹	280	N/A ¹	
Max. torque ² (A36/Grade 36 rod)	<i>T_{max}</i>	ft-lbs	10	25	50	90	125	165	N/A ¹	280	N/A ¹	
Max. torque ³ (Class 1 SS rod)	<i>T_{max}</i>	ft-lbs	5	20	40	60	100	165	N/A ¹	280	N/A ¹	
Minimum anchor spacing	<i>S_{min}</i>	inch (mm)	1 ⁷ / ₈ (48)	2 ¹ / ₂ (64)	3 ¹ / ₈ (79)	3 ³ / ₄ (95)	4 ³ / ₈ (111)	5 (127)	5 ⁵ / ₈ (143)	6 ¹ / ₄ (159)	6 ¹ / ₄ (159)	
Minimum edge distance	<i>C_{min}</i>	inch (mm)	5 <i>d</i> ; or see Section 4.1.9 of this report for installation parameters with reduced minimum edge distances (with reduced torque)									
Minimum member thickness	<i>h_{min}</i>	inch (mm)	<i>h_{ef}</i> + 1 ¹ / ₄ (<i>h_{ef}</i> + 30)			<i>h_{ef}</i> + 2 <i>d_o</i>						

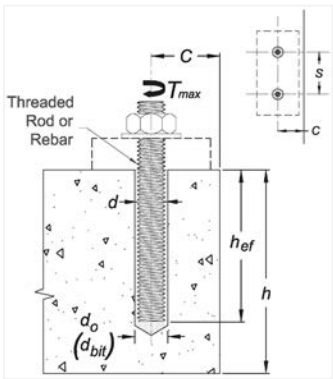

For **SI**: 1 inch = 25.4 mm, 1 ft-lbf = 1.356 N-m. For **pound-inch** units: 1 mm = 0.03937 inch, 1 N-m = 0.7375 ft-lbf.

¹N/A = Not Applicable.

²These values apply to ASTM A36 / F1554 Grade 36 carbon steel threaded rods.

³These values apply to ASTM A193 Grade B8/B8M (Class 1) stainless steel threaded rods.



FIGURE 3—AC100+ GOLD ADHESIVE ANCHOR SYSTEM INCLUDING TYPICAL STEEL ANCHOR ELEMENTS

TABLE 10—EXAMPLE OF AC100+ GOLD ADHESIVE ANCHOR ALLOWABLE STRESS DESIGN (ASD) VALUES FOR ILLUSTRATIVE PURPOSES^{1,2,3,4,6,9,10,13,14,16,17}

NOMINAL ANCHOR ROD DIAMETER OR REBAR SIZE <i>d</i> (inch) / (No.)	EFFECTIVE EMBED. ⁵ <i>h_{ef}</i> (inches)	CONCRETE STRENGTH ¹² <i>f_c</i> (psi)	EFFECTIVE-NESS FACTOR FOR UNCRACKED CONCRETE <i>k_{uncr}</i>	CHARACTERISTIC BOND STRENGTH <i>τ_{k,uncr}</i> (psi)		NOMINAL STRENGTH IN TENSION <i>N_n</i> (pounds)		STRENGTH REDUCTON FACTOR <i>φ</i> ¹⁵		ALLOWABLE TENSION LOAD ¹¹ <i>φ N_n / α</i> (pounds)	
				122°F LT, 176°F ST ⁷	162°F LT, 248°F ST ⁸	122°F LT, 176°F ST ⁷	162°F LT, 248°F ST ⁸	122°F LT, 176°F ST ⁷	162°F LT, 248°F ST ⁸	122°F LT, 176°F ST ⁷	162°F LT, 248°F ST ⁸
ASTM A193 Grade B7 Threaded Rod											
3/8	2 3/8	2,500	24	823	405	2,303	1,133	0.65 (bond)	0.65 (bond)	1,010	495
	4 1/2	2,500	24	823	405	4,363	2,147	0.65 (bond)	0.65 (bond)	1,915	945
1/2	2 3/4	2,500	24	823	405	3,555	1,749	0.65 (bond)	0.65 (bond)	1,560	765
	10	2,500	24	823	405	7,757	3,817	0.65 (bond)	0.65 (bond)	3,405	1,675
5/8	3 1/8	2,500	24	823	405	5,050	2,485	0.65 (bond)	0.65 (bond)	2,215	1,090
	12 1/2	2,500	24	823	405	12,120	5,964	0.65 (bond)	0.65 (bond)	5,325	2,620
3/4	3 1/2	2,500	24	823	405	6,787	3,340	0.65 (bond)	0.65 (bond)	2,980	1,465
	15	2,500	24	823	405	17,452	8,588	0.65 (bond)	0.65 (bond)	7,665	3,770
7/8	3 1/2	2,500	24	823	405	7,857	3,897	0.65 (conc)	0.65 (bond)	3,450	1,715
	17 1/2	2,500	24	823	405	23,755	11,690	0.65 (bond)	0.65 (bond)	10,430	5,135
1	4	2,500	24	743	366	9,337	4,599	0.65 (bond)	0.65 (bond)	4,100	2,020
	20	2,500	24	743	366	28,010	13,798	0.65 (bond)	0.65 (bond)	12,300	6,060
1 1/4	5	2,500	24	588	N/A	11,545	N/A	0.65 (bond)	N/A	5,070	N/A
	25	2,500	24	588	N/A	34,636	N/A	0.65 (bond)	N/A	15,215	N/A
ASTM A706 Grade 60 Reinforcing Bar											
3	2 3/8	2,500	24	823	405	2,303	1,133	0.65 (bond)	0.65 (bond)	1,010	495
	4 1/2	2,500	24	823	405	4,363	2,147	0.65 (bond)	0.65 (bond)	1,915	945
4	2 3/4	2,500	24	823	405	3,555	1,749	0.65 (bond)	0.65 (bond)	1,560	765
	10	2,500	24	823	405	7,757	3,817	0.65 (bond)	0.65 (bond)	3,405	1,675
5	3 1/8	2,500	24	823	405	5,050	2,485	0.65 (bond)	0.65 (bond)	2,215	1,090
	12 1/2	2,500	24	823	405	12,120	5,964	0.65 (bond)	0.65 (bond)	5,325	2,620
6	3 1/2	2,500	24	823	405	6,787	3,340	0.65 (bond)	0.65 (bond)	2,980	1,465
	15	2,500	24	823	405	17,452	8,588	0.65 (bond)	0.65 (bond)	7,665	3,770
7	3 1/2	2,500	24	823	405	7,857	3,897	0.65 (conc)	0.65 (bond)	3,450	1,715
	17 1/2	2,500	24	823	405	23,755	11,690	0.65 (bond)	0.65 (bond)	10,430	5,135
8	4	2,500	24	743	366	9,337	4,599	0.65 (bond)	0.65 (bond)	4,100	2,020
	20	2,500	24	743	366	28,010	13,798	0.65 (bond)	0.65 (bond)	12,300	6,060
9	4 1/2	2,500	24	665	329	11,545	5,233	0.65 (bond)	0.65 (bond)	5,070	2,295
	22 1/2	2,500	24	665	329	34,636	15,698	0.65 (bond)	0.65 (bond)	15,215	6,895
10	5	2,500	24	588	N/A	11,545	N/A	0.65 (bond)	N/A	5,070	N/A
	25	2,500	24	588	N/A	34,636	N/A	0.65 (bond)	N/A	15,215	N/A

For **SI**: 1 inch = 25.4 mm, 1 lbf = 4.448 N, 1 psi = 0.006894 MPa. For **pound-inch** units: 1 mm = 0.03937 inch, 1 N = 0.2248 lbf, 1 MPa = 145.0 psi.

¹Single anchor with static tension load only; ASTM A193 Grade B7 threaded rod and ASTM A706 Grade 60 reinforcing bar.

²Vertical downward installation direction.

³Special inspection interval = Periodic.

⁴Installation temperature = 23°F (-5°C) to 104°F (40°C) for base material; 23°F (-5°C) to 95°F (35°C) for cartridge adhesive.

⁵Embedment = *h_{ef,min}* and *h_{ef,max}* for each diameter.

⁶Concrete determined to remain uncracked for the life of the anchorage.

⁷Long-term service temperature = 122°F (50°C), short-term service temperature = 176°F (80°C).

⁸Long-term service temperature = 162°F (72°C), short-term service temperature = 248°F (120°C).

⁹Load combinations are based on ACI 318-19 Section 5.3, as applicable, with no seismic loading considered.

¹⁰Thirty percent (30%) dead load and seventy percent (70%) live load; controlling load combination 1.2D + 1.6L.

¹¹Calculation of weighted average for the conversion factor, $\alpha = 1.2(0.3) + 1.6(0.7) = 1.48$.

¹²*f_c* = 2,500 psi compressive strength (normal-weight concrete).

¹³*C_{at}* = *C_{a2}* ≥ *C_{ac}*.

¹⁴*h* ≥ *h_{min}*.

¹⁵Strength reduction factor from controlling nominal strength in tension [i.e. steel, concrete (conc), bond] decisive from design assumptions.

¹⁶Hammer-drilled holes in dry concrete.

¹⁷N/A = not applicable

TABLE 11— APPLICABLE SECTIONS OF THE IBC CODE UNDER EACH EDITION OF THE IBC

2024 IBC	2021 IBC	2018 IBC	2015 IBC
Section 1605.1		Section 1605.2 or 1605.3	
	Section 1705.1.1		
	Table 1705.3		
	Section 1705		
	Section 1706		
	Section 1707		
	Section 1901.3		
	Section 1903		
	Section 1905		
Section 1905.1.8		Section 1905.1.8	

TABLE 12— APPLICABLE SECTIONS OF ACI 318 UNDER EACH EDITION OF THE IBC

2024 IBC	2021 IBC	2018 IBC	2015 IBC
ACI 318-19		ACI 318-14	
2.3		2.3	
5.3		5.3	
Chapter 17		Chapter 17	
17.2.4		17.2.6	
17.3.1		17.2.7	
17.5.1		17.3.1.1	
17.5.1.2		17.3.1	
17.5.3		17.3.3	
17.6.1.2		17.4.1.2	
Eq. 17.6.1.2		17.4.1.2	
17.6.2		17.4.2	
17.6.2.2		17.4.2.2	
17.6.2.5		17.4.2.6	
17.6.5		17.4.5	
Eq 17.6.5.1.2b		Eq 17.4.5.1d	
Eq 17.6.5.2.1		Eq 17.4.5.2	
17.6.5.5		17.4.5.5	
Eq. 17.6.5.5.1b		Eq. 17.4.5.5b	
Eq. 17.6.5.5.1c		Eq. 17.4.5.5c	
17.7.1.2		17.5.1.2	
Eq. 17.7.1.2(b)		Eq. 17.5.1.2b	
17.7.2		17.5.2	
17.7.2.2		17.5.2.2	
17.7.3		17.5.3	
17.8		17.6	
17.9.2		17.7.1 and 17.7.3	
17.9.3		17.7.4	
17.9.5		17.7.6	
17.10		17.2.3	
17.10.5.3(a)(vi),		17.2.3.4.3(a)vi	
20.2.2.4 and 20.2.2.5		20.2.2.4 and 20.2.2.5	
26.6.3.2 (b)		26.6.3.1 (b)	
26.7.2		17.8.1 and 17.8.2	
26.7.1(l) and 26.7.2(e)		17.8.2.2 or 17.8.2.3	
26.13.3.2(e)		17.8.2.4, 26.7.1(h) and 26.13.3.2(c)	

AC100+ Gold Instruction Card

DESCRIPTION:

AC100+ Gold is an easy dispensing, rapid-curing, anchoring adhesive which is formulated for use in anchoring applications by trained professionals. Please refer to installation instructions and SDS for additional detailed information.

PRECAUTION:

Safety glasses and dust masks should be used when drilling holes into concrete, stone and masonry. Wear gloves and safety glasses when handling and dispensing adhesive. Do not sand the adhesive and create silica dust which could be inhaled. Avoid skin and eye contact. Use a NIOSH-approved chemical mask to avoid respiratory discomfort if working indoors or in a confined area, or if sensitive to adhesive odors. Wash hands or other affected body parts with soap and water if skin contact occurs. Flush eyes with plenty of water and seek immediate medical attention if eye contact occurs. Move to fresh air if adhesive odor begins to cause discomfort.

IMPORTANT! Before using, read and review Safety Data Sheet (SDS).

This product contains crystalline silica and as supplied does not pose a dust hazard. IARC classifies crystalline silica (quartz sand) as a Group 1 carcinogen based upon evidence among workers in industries where there has been long-term and chronic exposure (via inhalation) to silica dust, e.g. mining, quarry, stone crushing, refractory brick and pottery workers. This product does not pose a dust hazard, therefore, this classification is not relevant. However, if reacted (fully cured) product is further processed (e.g. sanded, drilled) be sure to wear proper respiratory and eye protection to avoid health risk.

HANDLING AND STORAGE:

Store in a cool, dry, well ventilated area at temperatures between 32°F (0°C) and 86°F (30°C). Do not freeze. Store and keep away from flame, heat and light. Keep partially used containers closed when not in use. Protect from damage.



Note expiration date on product label before use. Do not use expired product. Partially used cartridges may be stored with hardened adhesive in the attached mixing nozzle. Note: If the cartridge is reused, attach a new mixing nozzle and discard the initial quantity of the anchor adhesive as described in the setting instructions.

DEWALT
701 East Joppa Road
Towson, MD 21286 U.S.A.
anchors@DEWALT.com
www.DEWALT.com
P: (800) 524-3244

[V] Adhesive piston plugs	Rebar Drill bit size (in.)	Piston size (in.)	Piston Plug (Cat. #)	Horizontal and overhead installations ^{1,2}
5/8	1 1/16	1 1/16	Standard 08258-PWR PFC1691515	
3/4	7/8	3/4	Premium 08258-PWR PFC1691520	
3/4	#6	7/8	08300-PWR PFC1691530	
7/8	#7	1	08301-PWR PFC1691540	
1	#8	1 1/8	08303-PWR PFC1691550	
1 1/4	#9	1 3/8	08305-PWR PFC1691560	
-	#10	1 1/2	08308-PWR PFC1691570	

¹ A plastic extension tube (Cat# 082831) or equivalent approved by DEWALT must be used with piston plugs.
² All listed overhead anchor installations require piston plugs, horizontal installations with embedments greater than 8 inches require piston plugs.

[I.] Hole cleaning tools - wire brushes and air blowers

Threaded rod diameter (in.)	Rebar size (No.)	Drill bit size ¹ (in.)	Brush length (inches)	Steel wire brush (Cat. #)	Air blowers
3/8	#3	7/16	6 3/4	08284	 Hand pump (volume 2.5 fl. oz.), Cat. #08280-PWR or compressed air nozzle (min. 90 psi)
1/2	-	9/16	6 1/4	08285	
5/8	#4	5/8	6 3/4	08275	 Compressed air nozzle only (min. 90 psi), Cat. #08292-PWR or DFC165100
3/4	#5	11/16	7 1/8	08286	
7/8	#6	3/4	7 1/8	08278	
1	#7	7/8	7 1/8	08287	
1 1/4	#8	1	11 7/8	08288	
-	#9	1 1/8	11 7/8	08289	
-	#10	1 1/2	11 7/8	08290	
-	-	-	11 7/8	08291	

¹ A brush extension (Cat. #08282) must be used with brushes for holes drilled deeper than the listed brush length. For installations with 5/8-inch threaded rod and #5 rebar size, the preferred ANSI drill bit diameter is 3/4-inch. If an 11/16-inch ANSI drill bit is used the user must check before injecting the adhesive to verify that the steel anchor element can be inserted into the cleaned hole without resistance.

[II.] Gel (working) times and curing times

Temperature of base material	Gel (working) time	Full curing time
14°F	90 minutes	24 hours
23°F	90 minutes	14 hours
32°F	45 minutes	7 hours
41°F	25 minutes	2 hours
68°F	6 minutes	45 minutes
86°F	4 minutes	25 minutes
104°F	1.5 minutes	15 minutes

Linear interpolation for intermediate base material temperatures is possible. For installations in base material temperature between 14°F and 23°F the cartridge temperature must be conditioned to between 68°F and 95°F (20°C - 35°C).

[III.] Installation parameters - Specifications for installation of threaded rods and reinforcing bars

Anchor property / Setting information	3/8 or #3	1/2	#4	5/8 or #5	3/4 or #6	7/8 or #7	1 or #8	#9	1 1/4	#10
<i>d</i> = Threaded rod outside diameter (in.)	0.375	0.500	0.625	0.750	0.875	1.000	1.000	1.250	-	1.250
<i>d</i> = Nominal rebar diameter (in.)	0.375	0.500	0.625	0.750	0.875	1.000	1.125	-	-	1.250
<i>d</i> ₀ (<i>d</i> ₀) = Nominal ANSI drill bit size (in.)	7/16	9/16	5/8	11/16 or 3/4	7/8	1	1 1/8	1 1/8	1 3/8	1 1/2
<i>h</i> _{rebar} = Minimum embedment (inches)	2 3/8	2 3/4	3 1/8	3 1/2	3 1/2	3 1/2	4	4 1/2	5	5
<i>h</i> _{max} = Maximum embedment (inches)	4 1/2	6	7 1/2	9	10 1/2	12	13 1/2	15	15	15
<i>S</i> _{min} = Minimum spacing (inches)	1 7/8	2 1/4	3 1/8	3 1/4	4 3/8	5	5 9/8	6 1/4	6 1/4	6 1/4
<i>C</i> _{min} = Minimum edge distance (inches)	1 3/4	1 3/4	1 3/4	1 3/4	1 3/4	1 3/4	1 3/4	2 3/4	2 3/4	2 3/4
<i>h</i> _{min} = Minimum member thickness (inches)	15	33	60	105	125	165	280	-	-	-
<i>T</i> _{max} = Maximum rod torque (ft.-lb.) for A36/Grade 36 rod	10	25	50	90	125	165	280	-	-	-
<i>T</i> _{max} = Maximum torque (ft.-lb.) for Grade B818/B888 Class 1 rod	5	20	40	60	100	165	280	-	-	-

For installations between the minimum edge distance and *S*_d the tabulated maximum torque must be reduced (multiplied) by a factor of 0.45.

[IV.] AC100+ Gold adhesive anchor system selection table

Dispensers (catalyzing guns)	Cat. #08437-PWR - Manual tool	AC100+ Gold 9.5 fl. oz. Quick-Shot w/nozzle	Mixing nozzle
Manual dispensers	Cat. #08414-PWR - Manual tool	AC100+ Gold 14 fl. oz. coaxial cart. w/nozzle	Mixing nozzle and extension tube Cat. #08293-PWR or PFC1641600
Manual and powered dispensers	Cat. #08494-PWR - Manual tool Cat. #08496-PWR - Pneumatic tool Cat. #DCE5901 - Cordless battery tool	AC100+ Gold 28 fl. oz. dual cart. w/nozzle	Long mixing nozzle and extension tube Cat. #08294-PWR, 08609-PWR or PFC1641600

A plastic extension tube (Cat# 082831-PWR or 08297-PWR) or flexible extension hose (Cat# PFC1640600) or equivalent approved by DEWALT must be used if the bottom or back of the anchor hole is not reached with the mixing nozzle only.

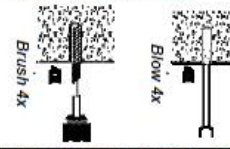
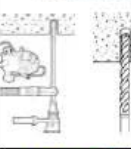
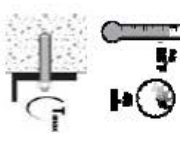
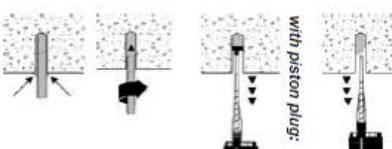

FIGURE 4—MANUFACTURER’S PUBLISHED INSTALLATION INSTRUCTIONS (MPII)

AC100+ Gold - Instruction Card (continued)

<p style="text-align: center;">HOLE CLEANING DRY OR WET HOLES</p>  <p style="text-align: center;">Repeat Blowing 4x</p> <p style="text-align: center;">Brush 4x</p> <p style="text-align: center;">Blow 4x</p> <p>2.2a Starting from the bottom or back of the drilled anchor hole, blow the hole clean a minimum of four times (4X). Use a compressed air nozzle (min. 90 psi) for all sizes of anchor rod and reinforcing bar (rebar). Alternatively, a hand pump (min. volume 25 fl. oz. supplied by DEWALT) may be used for anchor rods 3/8" to 3/4" diameter or reinforcing bar (rebar) sizes #3 to #6 for embedments not more than 8 inches (a hand pump must not be used with larger anchor sizes).</p> <p>2.2b Determine brush diameter (see Table I) for the drilled hole and attach the brush with an adaptor to a rotary drill tool or battery screw gun. Brush the hole with the selected wire brush a minimum of four times (4X).</p> <p>A brush extension (supplied by DEWALT) must be used for holes drilled deeper than the listed brush length. The wire brush diameter must be checked periodically during use; the brush should resist insertion into the drilled hole, if not the brush is too small and must be replaced with the proper brush diameter (i.e. new wire brush).</p> <p>2.2c Repeat Step 2a again by blowing the hole clean a minimum of four times (4X). When finished the hole should be clean and free of dust, debris, ice, grease, oil or other foreign material. → Next go to Step 3.</p>	<p style="text-align: center;">HAMMER DRILLING</p>  <p>2.1 Drill a hole into the base material with rotary hammer drill (i.e. percussion drill) and a carbide drill bit to the size and embedment required by the selected steel hardware element (see Table III). Tolerances of carbide drill bits including hollow drill bits must meet ANSI Standard B212.15.</p> <p>Precaution: Wear suitable eye and skin protection. Avoid inhalation of dusts during drilling and/or removal (see dust extraction equipment by DEWALT to minimize dust emissions).</p> <p>Notes: In case of standing water in the drilled hole (flooded hole condition), all the water has to be removed from the hole (e.g. vacuum, compressed air, etc.) prior to cleaning. Drilling in dry concrete is recommended when using hollow drill bits (vacuum must be on).</p>
---	--

SELECT HAMMER DRILLING AS SUITABLE FOR APPLICATION

Installation instructions for Adhesive Anchors in solid base material – For any application not covered by this document please contact DEWALT

<p style="text-align: center;">CURING AND FIXTURE</p>  <p>10 After full curing of the adhesive anchor, a fixture can be installed to the anchor and tightened up to the maximum torque (shown in Table III) by using a calibrated torque wrench. Note: Take care not to exceed the maximum torque for the selected anchor.</p>	<p style="text-align: center;">INSTALLATION</p>  <p style="text-align: center;">with piston plug:</p> <p>7 The anchor should be free of dirt, grease, oil or other foreign material. Push clean threaded rod or reinforcing bar into the anchor hole while turning slightly to ensure positive distribution of the adhesive until the embedment depth is reached. Observe the gel (working) time.</p> <p>8 Ensure that the anchor element is installed to the specified embedment depth. Adhesive must completely fill the annular gap at the concrete surface. Following installation of the anchor element, remove excess adhesive. Protect the anchor element threads from fouling with adhesive.</p> <p>For all installations the anchor element must be restrained from movement throughout the specified curing period (where necessary) through the use of temporary wedges, external supports, or other methods. Minor adjustments to the position of the anchor element may be performed during the gel time only.</p> <p>9 Allow the adhesive anchor to cure to the specified full curing time prior to applying any load (see Table II). Do not disturb, torque or load the anchor until it is fully cured.</p>	<p style="text-align: center;">PREPARING</p>  <p>2 Check adhesive expiration date on cartridge label. Do not use expired product. Review Safety Data Sheet (SDS) before use. Cartridge temperature must be between 23°F - 104°F (-5°C - 40°C) when in use except as noted in Table II. Review published working and cure times. Consideration should be given to the reduced gel (working) time of the adhesive in warm temperatures. For the permitted range of the base material temperature see Table II.</p> <p>Attach a supplied mixing nozzle to the cartridge. Do not modify the mixer in any way and make sure the mixing element is inside the nozzle. Load the cartridge into the correct dispensing tool.</p> <p>Note: Always use a new mixing nozzle with new cartridges of adhesive and also for all work interruptions exceeding the published gel (working) time of the adhesive.</p> <p>3 Prior to inserting the anchor rod or rebar into the filled hole, the position of the embedment depth has to be marked on the anchor. Verify anchor element is straight and free of surface damage.</p> <p>4 Adhesive must be properly mixed to achieve published properties. Prior to dispensing adhesive into the drilled hole, separately dispense at least three full strokes of adhesive through the mixing nozzle until the adhesive is a consistent gray color.</p> <p>Review and note the published working and cure times (see Table II) prior to injection of the mixed adhesive into the cleaned anchor hole.</p> <p>5 Fill the cleaned hole approximately two-thirds full with mixed adhesive starting from the bottom or back of the anchor hole. If the bottom or back of the anchor hole is not reached with the mixing nozzle only, a plastic extension tube must be used (see Table IV). Slowly withdraw the mixing nozzle as the hole fills to avoid creating air pockets or voids.</p> <p>Note: Piston plugs (see Table V) must be used with and attached to mixing nozzle and extension tube for overhead and horizontal installations with anchor rod 5/8" to 1-1/4" diameter and rebar size #5 to #10. Insert piston plug to the back of the drilled hole and inject as described in the method above. During installation the piston plug will be naturally extruded from the drilled hole by the adhesive pressure. Attention! Do not install anchors overhead without proper training and installation hardware provided by DEWALT. Contact DEWALT prior to use.</p>
---	--	--

FOLLOW STEPS #1 THROUGH #10 FOR RECOMMENDED INSTALLATION

FIGURE 4—MANUFACTURER'S PUBLISHED INSTALLATION INSTRUCTIONS (MPII) (continued)

DIVISION: 03 00 00—CONCRETE
Section: 03 16 00—Concrete Anchors

DIVISION: 05 00 00—METALS
Section: 05 05 19—Post-installed Concrete Anchors

REPORT HOLDER:

DEWALT

EVALUATION SUBJECT:**AC100+ GOLD® ADHESIVE ANCHOR SYSTEM IN CRACKED AND UNCRACKED CONCRETE (DEWALT)****1.0 REPORT PURPOSE AND SCOPE****Purpose:**

The purpose of this evaluation report supplement is to indicate that AC100+ Gold adhesive anchor system in cracked and uncracked concrete, described in ICC-ES evaluation report [ESR-2582](#), has also been evaluated for compliance with the codes noted below as adopted by Los Angeles Department of Building and Safety (LADBS).

Applicable code editions:

- 2023 *City of Los Angeles Building Code* ([LABC](#))
- 2023 *City of Los Angeles Residential Code* ([LARC](#))

2.0 CONCLUSIONS

The AC100+ Gold adhesive anchor system in cracked and uncracked concrete, described in Sections 2.0 through 7.0 of the evaluation report [ESR-2582](#), complies with LABC Chapter 19, and LARC, and is subject to the conditions of use described in this report.

3.0 CONDITIONS OF USE

The AC100+ Gold adhesive anchor system described in this evaluation report supplement must comply with all of the following conditions:

- All applicable sections in the evaluation report [ESR-2582](#).
- The design, installation, conditions of use and labeling of the anchor system are in accordance with the 2021 *International Building Code*® (IBC) provisions noted in the evaluation report [ESR-2582](#).
- The design, installation and inspection are in accordance with additional requirements of LABC Chapters 16 and 17, as applicable.
- Under the LARC, an engineered design in accordance with LARC Section R301.1.3 must be submitted.
- The allowable and strength design values listed in the evaluation report and tables are for the connection of the anchor system to the concrete. The connection between the anchor system and the connected members shall be checked for capacity (which may govern).
- For use in wall anchorage assemblies to flexible diaphragm applications, anchors shall be designed per the requirements of City of Los Angeles Information Bulletin P/BC 2023-071.

This supplement expires concurrently with the evaluation report, reissued February 2025.

DIVISION: 03 00 00—CONCRETE

Section: 03 16 00—Concrete Anchors

DIVISION: 05 00 00—METALS

Section: 05 05 19—Post-Installed Concrete Anchors

REPORT HOLDER:

DEWALT

EVALUATION SUBJECT:

AC100+ GOLD® ADHESIVE ANCHOR SYSTEM IN CRACKED AND UNCRACKED CONCRETE (DEWALT)

1.0 REPORT PURPOSE AND SCOPE**Purpose:**

The purpose of this evaluation report supplement is to indicate that the AC100+ Gold Adhesive Anchor System in cracked and uncracked concrete, described in ICC-ES evaluation report ESR-2582, has also been evaluated for compliance with the codes noted below.

Applicable code editions:

- 2023 Florida Building Code—Building
- 2023 Florida Building Code—Residential

2.0 CONCLUSIONS

The AC100+ Gold® Adhesive Anchor System in cracked and uncracked concrete, described in Sections 2.0 through 7.0 of the evaluation report ESR-2582, complies with the *Florida Building Code—Building* and the *Florida Building Code—Residential*. The design requirements must be determined in accordance with the *Florida Building Code—Building* or the *Florida Building Code—Residential*, as applicable. The installation requirements noted in ICC-ES evaluation report ESR-2582 for the 2021 *International Building Code*® meet the requirements of the *Florida Building Code—Building* or the *Florida Building Code—Residential*, as applicable.

Use of the AC100+ Gold® adhesive anchors has also been found to be in compliance with the High-Velocity Hurricane Zone provisions of the *Florida Building Code—Building* and *Florida Building Code—Residential* with the following condition:

- a) For connections subject to uplift, the connection must be designed for no less than 700 pounds (3114 N).

For products falling under Florida Rule 61G20-3, verification that the report holder's quality assurance program is audited by a quality assurance entity approved by the Florida Building Commission for the type of inspections being conducted is the responsibility of an approved validation entity (or the code official, when the report holder does not possess an approval by the Commission).

This supplement expires concurrently with the evaluation report, reissued February 2025.