

# ICC-ES Evaluation Report

ESR-3576

Reissued July 2024

Revised October 2024



Subject to renewal July 2025

This report also contains:

- [FL Supplement w/ HVHZ](#)

ICC-ES Evaluation Reports are not to be construed as representing aesthetics or any other attributes not specifically addressed, nor are they to be construed as an endorsement of the subject of the report or a recommendation for its use. There is no warranty by ICC Evaluation Service, LLC, express or implied, as to any finding or other matter in this report, or as to any product covered by the report.

Copyright © 2024 ICC Evaluation Service, LLC. All rights reserved.

<p><b>DIVISION: 03 00 00— CONCRETE</b></p> <p><b>Section: 03 16 00— Concrete Anchors</b></p> <p><b>DIVISION: 05 00 00— METALS</b></p> <p><b>Section: 05 05 19— Post-installed Concrete Anchors</b></p>	<p><b>REPORT HOLDER:</b> <b>DEWALT</b></p> 	<p><b>EVALUATION SUBJECT:</b> <b>PURE50+™ EPOXY ADHESIVE ANCHOR SYSTEM IN CRACKED AND UNCRACKED CONCRETE (DEWALT)</b></p>	
--	--	---	---

## 1.0 EVALUATION SCOPE

### Compliance with the following codes:

- 2024, 2021, 2018 and 2015 [International Building Code® \(IBC\)](#)
- 2024, 2021, 2018 and 2015 [International Residential Code® \(IRC\)](#)

Main references of this report are for the 2024 IBC and IRC. See [Table 10](#) and [Table 11](#) for applicable sections of the code for previous IBC and IRC editions.

### Property evaluated:

- Structural

## 2.0 USES

The Pure50+ epoxy adhesive anchors are used to resist static; wind or earthquake (IBC Seismic Design Categories A through F) tension and shear loads in cracked and uncracked normal-weight concrete or lightweight concrete with a specified compressive strength,  $f'_c$ , of 2,500 psi to 8,500 psi (17.2 MPa to 58.6 MPa).

The anchor system complies with anchors described in Section 1901.3 of the 2024 IBC. The anchor systems may also be used where an engineered design is submitted in accordance with Section R301.1.3 of the IRC.

## 3.0 DESCRIPTION

### 3.1 General:

The Pure50+ Epoxy Adhesive Anchor System is comprised of a two-component epoxy adhesive filled in cartridges, static mixing nozzles, dispensing tools, hole cleaning equipment and adhesive injection accessories. The Pure50+ epoxy adhesive may be used with continuously threaded steel rods or deformed steel reinforcing bars.

The adhesive and steel anchor elements are installed in pre-drilled holes into concrete. The primary components of the Pure50+ Epoxy Adhesive Anchor System, including the epoxy adhesive cartridge, static mixing nozzle, the nozzle extension tube, dispensing tool, and typical steel anchor elements, are shown in [Figure 2](#) of this report. Manufacturer's printed installation instructions (MPII) and parameters, included with each adhesive unit package, are shown in [Figure 3](#) of this report.

### 3.2 Materials:

**3.2.1 Pure50+ Epoxy Adhesive:** Pure50+ epoxy adhesive is an injectable two-component epoxy. The two components are separated by means of a labeled dual-cylinder cartridge. The two components combine and react when dispensed through a static mixing nozzle, supplied by DEWALT, which is attached to the cartridge. A nozzle extension tube is also packaged with the cartridge. The Pure50+ epoxy adhesive is available in 9-ounce (265 mL), 9.5-ounce (280 mL), 20.5-ounce (610 mL) and 50.5-ounce (1500 mL). Each cartridge label is marked with the adhesive expiration date. The shelf life, as indicated by the expiration date, applies to an unopened cartridge when stored in accordance with the MPII, as illustrated in [Figure 3](#).

**3.2.2 Hole Cleaning Equipment:** Standard hole cleaning equipment and dust extraction system equipment (i.e. suction, vacuum) are available from the report holder.

**3.2.2.1 Standard hole cleaning:** Standard hole cleaning equipment used after drilling is comprised of steel wire brushes supplied by DEWALT and a compressed air nozzle. Standard hole cleaning equipment is shown in [Figure 3](#).

**3.2.2.2 DustX+™ extraction system:** The DustX+™ extraction system automatically cleans the holes during drilling using hollow drill bits with a carbide head meeting the requirements of ANSI B212.15 and a DEWALT DWV012 / DWV902M vacuum equipped with an automatic filter cleaning system or equivalent approved by DEWALT. After drilling with the DustX+ system, no further hole cleaning is required. See [Figure A](#) for illustration of the Dust+ extraction system.

**3.2.2.3 Dispensers:** Pure50+ epoxy adhesive must be dispensed with manual, pneumatic dispensers, or electric powered dispensers supplied by DEWALT.

### 3.2.3 Steel Anchor Elements:

**3.2.3.1 Threaded Steel Rods:** Threaded steel rods must be clean and continuously threaded (all-thread) in diameters as described in [Table 4](#) and [Figure 3](#) of this report. The embedded portions of threaded rods must be clean, straight, and free of mill scale, rust, and other coatings (other than zinc) that may impair the bond with the adhesive. Specifications for grades of threaded rod, including the mechanical properties and corresponding nuts and washers, are described in [Table 2](#) of this report. Carbon steel threaded rods may be furnished with a minimum 0.0002-inch-thick (0.005 mm) zinc electroplated coating complying with ASTM B633, SC1; or a minimum 0.0021-inch-thick (0.053 mm) mechanically deposited zinc coating complying with ASTM B695, Class 55; or hot dip galvanized zinc coating complying with ASTM A153, Class C or D. The stainless-steel threaded rods must comply with [Table 2](#) of this report. Steel grades and material types (carbon, stainless) of the washers and nuts must be matched to the threaded rods. Threaded steel rods must be straight and free of indentations or other defects along their length. The embedded end may be either flat cut or cut on the bias to a chisel point.

**3.2.3.2 Steel Reinforcing Bars:** Steel reinforcing bars are deformed reinforcing bars (rebars) as described in [Table 3](#) of this report. [Table 5](#) and [Figure 3](#) of this report summarize reinforcing bar size ranges. The embedded portions of reinforcing bars must be clean, straight, and free of mill scale, rust, and other coatings (other than zinc) that may impair the bond with the adhesive. Reinforcing bars must not be bent after installation, except as set forth in ACI 318-19 Section 26.6.3.2 (b), with the additional condition that the bars must be bent cold, and heating of the reinforcing bars to facilitate field bending is not permitted.

**3.2.3.3 Ductility:** In accordance with ACI 318-19 Section 2.3 in order for a steel anchor element to be considered ductile, the tested elongation must be at least 14 percent and the reduction of area must be at least 30 percent. Steel elements with a tested elongation of less than 14 percent or a reduction of area less than 30 percent, or both, are considered brittle. Values for various steel materials are provided in [Tables 2](#) and [3](#) of this report. Where values are nonconforming or unstated, the steel element must be considered brittle.

### 3.3 Concrete:

Normal-weight concrete and lightweight concrete must comply with Sections 1903 and 1905 of the IBC, as applicable. The specified compressive strength of the concrete must be from 2,500 psi to 8,500 psi (17.2 MPa to 58.6 MPa).

## 4.0 DESIGN AND INSTALLATION

### 4.1 Strength Design:

**4.1.1 General:** The design strength of anchors under the 2024 IBC, as well as the 2024 IRC must be determined in accordance with ACI 318-19 and this report. See [Table 1](#) for design use and table index.

The strength design of anchors must comply with ACI 318-19 Section 17.5.1.2, except as required in ACI 318-19 Section 17.10.

Design parameters are provided in [Table 4](#) through [7](#) of this report. Strength reduction factors,  $\phi$ , as given in ACI 318-19 Section 17.5.3, must be used for load combinations calculated in accordance with Section 1605.1 of the 2024 IBC, and ACI 318-19 Section 5.3.

**4.1.2 Static Steel Strength in Tension:** The nominal static steel strength of a single anchor in tension,  $N_{sa}$ , in accordance with ACI 318-19 Section 17.6.1.2 and the associated strength reduction factors,  $\phi$ , in accordance with ACI 318-19 Section 17.5.3, are provided in [Tables 4](#) and [5](#) for the anchor element types included in this report.

**4.1.3 Static Concrete Breakout Strength in Tension:** The nominal static concrete breakout strength of a single anchor or group of anchors in tension, must be calculated in accordance with ACI 318-19 Section 17.6.2 with the following addition:

The basic concrete breakout strength of a single anchor in tension,  $N_b$ , must be calculated in accordance with ACI 318-19 Section 17.6.2.2, using the selected values of  $k_{c,cr}$  and  $k_{c,uncr}$  as provided in the tables of this report. Where analysis indicates no cracking in accordance with ACI 318-19 Section 17.6.2.5,  $N_b$  must be calculated using  $k_{c,uncr}$  and  $\Psi_{c,N} = 1.0$ . See [Table 1](#). For anchors in lightweight concrete see ACI 318-19 Section 17.2.4. The value of  $f'_c$  used for calculation must be limited to 8,000 psi (55 MPa) in accordance with ACI 318-19 Section 17.3.1. Additional information for the determination of nominal bond strength in tension is given in Section 4.1.4 of this report.

**4.1.4 Static Bond Strength in Tension:** The nominal static bond strength of a single adhesive anchor or group of adhesive anchors in tension,  $N_a$  or  $N_{ag}$ , must be calculated in accordance with ACI 318-19 Section 17.6.5. Bond strength values are a function of the bond stress ( $\tau_{k,cr}$ ,  $\tau_{k,uncr}$ ), concrete state (cracked, uncracked), drilling method (hammer-drill), concrete compressive strength ( $f'_c$ ) and installation conditions (dry concrete, water-saturated concrete, water-filled holes).

Special inspection level is qualified as periodic for all anchors except as noted in Section 4.4 of this report. The selection of continuous special inspection level, with an onsite proof loading program, is not necessary and does not provide a benefit of a lower anchor category or an increase in the associated strength reduction factors for design. The following table summarizes the requirements.

CONCRETE STATE	DRILLING METHOD	BOND STRESS	CONCRETE STRENGTH	PERMISSIBLE INSTALLATION CONDITIONS	ASSOCIATED STRENGTH REDUCTION FACTOR
Cracked and Uncracked	Hammer-drill with carbide drill bit or DEWALT hollow bit	$\tau_{k,cr}$ OR $\tau_{k,uncr}$	$f'_c$	Dry concrete	$\phi_d$
				Water-saturated concrete	$\phi_{ws}$
	Hammer-drill with carbide drill bit			Water-filled hole (flooded)	$\phi_{wf}$

The bond strength values in this report, correspond to concrete compressive strength  $f'_c$  equal to 2,500 psi (17.2 MPa). For concrete compressive strength,  $f'_c$ , between 2,500 psi and 8,000 psi (17.2 MPa and 55.2 MPa), the tabulated characteristic bond strength may be increased by a factor of  $(f'_c / 2,500)^{0.23}$  [For **SI**:  $(f'_c / 17.2)^{0.23}$ ]. Where applicable, the modified bond strength values must be used in lieu of  $\tau_{k,cr}$  and  $\tau_{k,uncr}$  in ACI 318-19 Eq. 17.6.5.1.2b and 17.6.5.2.1. The resulting nominal bond strength must be multiplied by the associated strength reduction factor  $\phi_{nn}$ .

[Figure 1](#) of this report presents a flowchart for the establishment of the bond strength. Strength reduction factors for determination of the bond strength are given in [Table 7](#) of this report. The adjustments to the bond strength may be taken for increased concrete compressive strength as also noted in the footnotes to the corresponding tables. For anchors in lightweight concrete, see ACI 318-19 Section 17.2.4.

**4.1.5 Static Steel Strength in Shear:** The nominal static steel strength of a single anchor in shear as governed by the steel,  $V_{sa}$ , in accordance with ACI 318-19 Section 17.7.1.2, and strength reduction factors,  $\phi$ , in accordance with ACI 318-19 Section 17.5.3, are given in [Tables 4](#) and [5](#) of this report for the anchor element types included in this report. See [Table 1](#) for design use and table index.

**4.1.6 Static Concrete Breakout Strength in Shear:** The nominal concrete breakout strength of a single anchor or group of anchors in shear,  $V_{cb}$  or  $V_{cbg}$ , must be calculated in accordance with ACI 318-19 Section 17.7.2, based on information given in [Table 6](#) of this report. The basic concrete breakout strength of a single anchor in shear,  $V_b$ , must be calculated in accordance with ACI 318-19 Section 17.7.2.2, using the values of  $d$  given in [Tables 4](#) and [5](#) of this report for the corresponding anchor steel in lieu of  $d_a$ . In addition,  $h_{ef}$  must be substituted for  $\ell_e$ . In no case must  $\ell_e$  exceed  $8d$ . For anchors in lightweight concrete see ACI 318-19 Section 17.2.4. The value of  $f'_c$  must be limited to a maximum of 8,000 psi (55 MPa), in accordance with ACI 318-19 Section 17.3.1.

**4.1.7 Static Concrete Pryout Strength in Shear:** The nominal static pryout strength of a single anchor or group of anchors in shear,  $V_{cp}$  or  $V_{cpg}$ , shall be calculated in accordance with ACI 318-19 Section 17.7.3.

**4.1.8 Interaction of Tensile and Shear Forces:** For designs that include combined tension and shear, the interaction of tension and shear loads must be calculated in accordance with ACI 318-19 Section 17.8.

**4.1.9 Minimum Member Thickness  $h_{min}$ , Anchor Spacing  $s_{min}$ , Edge Distance  $c_{min}$ :** In lieu of ACI 318-19 Section 17.9.2, values of  $s_{min}$  and  $c_{min}$  described in this report must be observed for anchor design and installation. The minimum member thicknesses,  $h_{min}$ , described in this report must be observed for anchor design and installation. For adhesive anchors that will remain untorqued, ACI 318-19 Section 17.9.3 applies.

For anchors that will be torqued during installation, the maximum torque,  $T_{max}$ , must be reduced for edge distances less than five anchor diameters ( $5d$ ).  $T_{max}$  is subject to the edge distance,  $c_{min}$ , and anchor spacing,  $s_{min}$ , and must comply with the following requirements:

MAXIMUM TORQUE SUBJECT TO EDGE DISTANCE			
NOMINAL ANCHOR SIZE, $d$	MIN. EDGE DISTANCE, $c_{min}$	MIN. ANCHOR SPACING, $s_{min}$	MAXIMUM TORQUE, $T_{max}$
all sizes	$5d$	$5d$	$T_{max}$
$\frac{3}{8}$ in. to 1 in. (9.5 mm to 25.4 mm)	1.75 in. (45 mm)	$5d$	$0.45 \cdot T_{max}$
1-1/4 in. (31.8 mm)	2.75 in. (70 mm)	$5d$	$0.45 \cdot T_{max}$

For values of  $T_{max}$ , see [Table 8](#) and [Figure 3](#) of this report.

**4.1.10 Critical Edge Distance  $c_{ac}$  and  $\psi_{cp,Na}$ :** The modification factor  $\psi_{cp,Na}$ , must be determined in accordance with ACI 318-19 Section 17.6.5.5, except as noted below:

For all cases where  $c_{Na}/c_{ac} < 1.0$ ,  $\psi_{cp,Na}$  determined from ACI 318-19 Eq. 17.6.5.5.1b, need not be taken less than  $c_{Na}/c_{ac}$ . For all other cases,  $\psi_{cp,Na}$  shall be taken as 1.0.

The critical edge distance,  $c_{ac}$  must be calculated according to ACI 318-19 Eq. 17.6.5.5.1c, in lieu of ACI 318-19 Section 17.9.5.,

$$c_{ac} = h_{ef} \cdot \left( \frac{\tau_{k,uncr}}{1160} \right)^{0.4} \cdot \left[ 3.1 - 0.7 \frac{h}{h_{ef}} \right]$$

(ACI 318-19 Eq. 17.6.5.5.1c)

where

$\left[ \frac{h}{h_{ef}} \right]$  need not be taken as larger than 2.4; and where

$\tau_{k,uncr}$  = the characteristic bond strength stated in the tables of this report whereby  $\tau_{k,uncr}$  need not be taken as larger than:

$$\tau_{k,uncr} = \frac{k_{uncr} \sqrt{h_{ef} f'_c}}{\pi \cdot d_a} \tag{Eq. 4-1}$$

**4.1.11 Design Strength in Seismic Design Categories C, D, E and F:** In structures assigned to Seismic Design Category C, D, E or F under the IBC or IRC, anchors must be designed in accordance with ACI 318-19 Section 17.10, except as described below.

The nominal steel shear strength,  $V_{sa}$ , must be adjusted by  $\alpha_{V,seis}$  as given in [Tables 4](#) and [5](#) for the corresponding anchor steel. The nominal bond strength  $\tau_{kcr}$  need not be adjusted by  $\alpha_{N,seis}$  since  $\alpha_{N,seis} = 1.0$ .

**4.2 Allowable Stress Design (ASD):**

**4.2.1 General:** For anchors designed using load combinations in accordance with Section 1605.1 of the 2024 IBC (Allowable Stress Design), loads must be established using the equations below:

$$T_{allowable,ASD} = \phi N_n / \alpha \tag{Eq. 4-2}$$

and

$$V_{allowable,ASD} = \phi V_n / \alpha \tag{Eq. 4-3}$$

where

$T_{allowable,ASD}$  = Allowable tension load (lbf or kN).

$V_{allowable,ASD}$  = Allowable shear load (lbf or kN).

$\phi N_n$  = Lowest design strength of an anchor or anchor group in tension as determined in accordance with ACI 318-19 Chapter 17, 2024 IBC Section 1905.7, and Section 4.1 of this report, as applicable (lbf or kN).

$\phi V_n$  = Lowest design strength of an anchor or anchor group in shear as determined in accordance with ACI 318-19 Chapter 17, 2024 IBC Section 1905.7, and Section 4.1 of this report, as applicable (lbf or kN).

$\alpha$  = Conversion factor calculated as a weighted average of the load factors for the controlling load combination. In addition,  $\alpha$  must include all applicable factors to account for non-ductile failure modes and required over-strength.

The requirements for member thickness, edge distance and spacing, described in this report must apply. An example of allowable stress design values for various diameters, illustrative purposes is shown in [Table 9](#) of this report.

**4.2.2 Interaction of Tensile and Shear Forces:** Interaction must be calculated in accordance with ACI 318-19 Section 17.8 as follows:

For shear loads  $V \leq 0.2 V_{allowable,ASD}$ , the full allowable load in tension shall be permitted.

For tension loads  $T \leq 0.2 T_{allowable,ASD}$ , the full allowable load in shear shall be permitted.

For all other cases:

$$\frac{T}{T_{allowable,ASD}} + \frac{V}{V_{allowable,ASD}} \leq 1.2 \quad \text{Eq. (4-4)}$$

#### 4.3 Installation:

Installation parameters are illustrated in [Table 8](#) of this report. Installation must be in accordance with ACI 318-19 Section 26.7.2. Anchor locations must comply with this report and the plans and specifications approved by the code official. Installation of the Pure50+ Epoxy Adhesive Anchor System must be in accordance with the manufacturer's printed installation instructions (MPII) included in each unit package as described in [Figure 3](#) of this report.

The adhesive anchor system may be used for upwardly inclined orientation applications (e.g. overhead). Upwardly included and horizontal orientation applications are to be installed using piston plugs for the  $\frac{5}{8}$ -inch through  $1\frac{1}{4}$ -inch diameter threaded steel rods and No. 5 through No. 10 steel reinforcing bars, installed in the specified hole diameter, and attached to the mixing nozzle and extension tube supplied by DEWALT as described in [Figure 3](#) in this report. Upwardly included and horizontal orientation installation for the  $\frac{3}{8}$ -inch and  $\frac{1}{2}$ -inch diameter threaded steel rods, and No. 3 and No. 4 steel reinforcing bars may be injected directly to the end of the hole using a mixing nozzle with a hole depth  $h_0 \leq 10"$  (250 mm).

Installation of anchors in horizontal or upwardly inclined (overhead) orientations shall be fully restrained from movement throughout the specified curing period through the use of temporary wedges, external supports, or other methods. Where temporary restraint devices are used, their use shall not result in impairment of the anchor shear resistance.

#### 4.4 Special Inspection:

Periodic special inspection must be performed where required in accordance with Section 1705.1.1 and Table 1705.3 of the 2024 IBC and this report. The special inspector must be on the jobsite initially during anchor installation to verify the anchor type, anchor dimensions, concrete type, concrete compressive strength, adhesive identification and expiration date, hole dimensions, hole cleaning procedures, anchor spacing, edge distances, concrete thickness, anchor embedment, tightening torque and adherence to the manufacturer's printed installation instructions (MPII). The special inspector must verify the initial installations of each type and size of adhesive anchor by construction personnel on the site. Subsequent installations of the same anchor type and size by the same construction personnel are permitted to be performed in the absence of the special inspector. Any change in the anchor product being installed or the personnel performing the installation requires an initial inspection. For ongoing installations over an extended period, the special inspector must make regular inspections to confirm correct handling and installation of the product.

Continuous special inspection of adhesive anchors installed in horizontal or upwardly inclined orientations to resist sustained tension loads must be performed in accordance with ACI 318-19 Section 26.13.3.2(e).



Under the IBC, additional requirements as set forth in Section 1705 of the 2024 IBC must be observed, where applicable.

#### 4.5 Compliance with NSF/ANSI Standard 61:

The Pure50+ Epoxy Adhesive Anchor System complies with the requirements of NSF/ANSI Standard 61, as referenced in Section 605 of the 2024 *International Plumbing Code*<sup>®</sup> (IPC), and is certified for use in water distribution systems and may have a maximum exposed surface area to volume ratio of 216 square inches per 1000 gallons (3785 L) for water treatment applications.

### 5.0 CONDITIONS OF USE:

The Pure50+ Epoxy Adhesive Anchor System described in this report complies with or is a suitable alternative to what is specified in the codes listed in Section 1.0 of this report, subject to the following conditions:

- 5.1 Pure50+ epoxy adhesive anchors must be installed in accordance with this report and the manufacturer's printed installation instructions (MPII) as attached to each cartridge and described in [Figure 3](#) of this report.
- 5.2 The anchors described in this report must be installed in cracked or uncracked normal-weight concrete or lightweight concrete having a specified compressive strength,  $f'_c = 2,500$  psi to 8,500 psi (17.2 MPa to 58.6 MPa).
- 5.3 The values of  $f'_c$  used for calculation purposes must not exceed 8,000 psi (55 MPa).
- 5.4 Anchors must be installed in concrete base materials in holes predrilled in accordance with the installation instructions provided in [Figure 3](#) of this report.
- 5.5 Loads applied to the anchors must be adjusted in accordance with Section 1605.1 of the 2024 IBC for strength design and for allowable stress design.
- 5.6 Pure50+ epoxy adhesive anchors are recognized for use to resist short- and long-term loads, including wind and earthquake, subject to the conditions of this report.
- 5.7 In structures assigned to Seismic Design Categories C, D, E, and F under the IBC or IRC, anchor strength must be adjusted in accordance with Section 4.1.11 of this report, as applicable.
- 5.8 Pure50+ epoxy adhesive anchors are permitted to be installed in concrete that is cracked or that may be expected to crack during the service life of the anchor, subject to the conditions of this report.
- 5.9 Strength design values must be established in accordance with Section 4.1 of this report.
- 5.10 Allowable stress design values must be established in accordance with Section 4.2 of this report.
- 5.11 Minimum anchor spacing and edge distance, as well as minimum member thickness, must comply with the values described in this report.
- 5.12 Prior to anchor installation, calculations and details demonstrating compliance with this report must be submitted to the code official. The calculations and details must be prepared by a registered design professional where required by the statutes of the jurisdiction in which the project is to be constructed.
- 5.13 Anchors are not permitted to support fire-resistive construction. Where not otherwise prohibited by the code, Pure50+ epoxy adhesive anchors are permitted for installation in fire-resistive construction provided that at least one of the following conditions is fulfilled:
  - Anchors are used to resist wind or seismic forces only.
  - Anchors that support gravity load-bearing structural elements are within a fire-resistive envelope or a fire-resistive membrane, are protected by approved fire-resistive materials, or have been evaluated for resistance to fire exposure in accordance with recognized standards.
  - Anchors are used to support non-structural elements.
- 5.14 Since an ICC-ES acceptance criteria for evaluating data to determine the performance of adhesive anchors subjected to fatigue or shock loading is unavailable at this time, the use of these anchors under such conditions is beyond the scope of this report.
- 5.15 Use of zinc-plated carbon steel threaded rods or steel reinforcing bars is limited to dry, interior locations.
- 5.16 Use of hot-dipped galvanized carbon steel and stainless steel rods is permitted for exterior exposure or damp environments.
- 5.17 Steel anchoring materials in contact with preservative-treated wood and fire-retardant-treated wood must be of zinc-coated carbon steel or stainless steel. The minimum coating weights for zinc-coated steel must comply with ASTM A153.

- 5.18 Periodic special inspection must be provided in accordance with Section 4.4 of this report. Continuous special inspection for anchors installed in horizontal or upwardly inclined orientations to resist sustained tension loads must be provided in accordance with Section 4.4 of this report.
- 5.19 Installation of anchors in horizontal or upwardly inclined orientations to resist sustained tension loads must be performed by personnel certified by an applicable certification program in accordance with ACI 318-19 Section 26.7.1(l) and Section 26.7.2(e).
- 5.20 Pure50+ epoxy adhesive is manufactured under an approved quality control program with inspections by ICC-ES.

## 6.0 EVIDENCE SUBMITTED

- 6.1 Data in accordance with the [ICC-ES Acceptance Criteria for Post-installed Adhesive Anchors in Concrete Elements \(AC308\)](#), dated February 2023 (editorially revised February 2024), which incorporates requirements in ACI 355.4-19 and ACI 355.4-11 for use in cracked and uncracked concrete; including, but not limited to, tests under freeze/thaw conditions, tests under sustained load, tests for installation direction, tests at elevated temperatures, tests for resistance to alkalinity, tests for resistance to sulfur and tests for seismic tension and shear.

## 7.0 IDENTIFICATION

- 7.1 The ICC-ES mark of conformity, electronic labeling, or the evaluation report number (ICC-ES ESR-3576) along with the name, registered trademark, or registered logo of the report holder or listee must be included in the product label
- 7.2 In addition, the Pure50+ epoxy adhesive described in Section 3.1 of this report is identified by packaging labeled with the lot number, expiration date, company name and corresponding product name as set forth in Section 3.1 of this report. Threaded rods, nuts, washers, and deformed reinforcing bars are standard steel anchor elements and must conform to applicable national specifications as set forth in [Table 2](#) and [3](#) of this report.
- 7.3 The report holder's contact information is the following:

**DEWALT**  
**701 EAST JOPPA ROAD**  
**TOWSON, MARYLAND 21286**  
**(800) 524-3244**  
[www.DEWALT.com](http://www.DEWALT.com)  
[anchors@DEWALT.com](mailto:anchors@DEWALT.com)

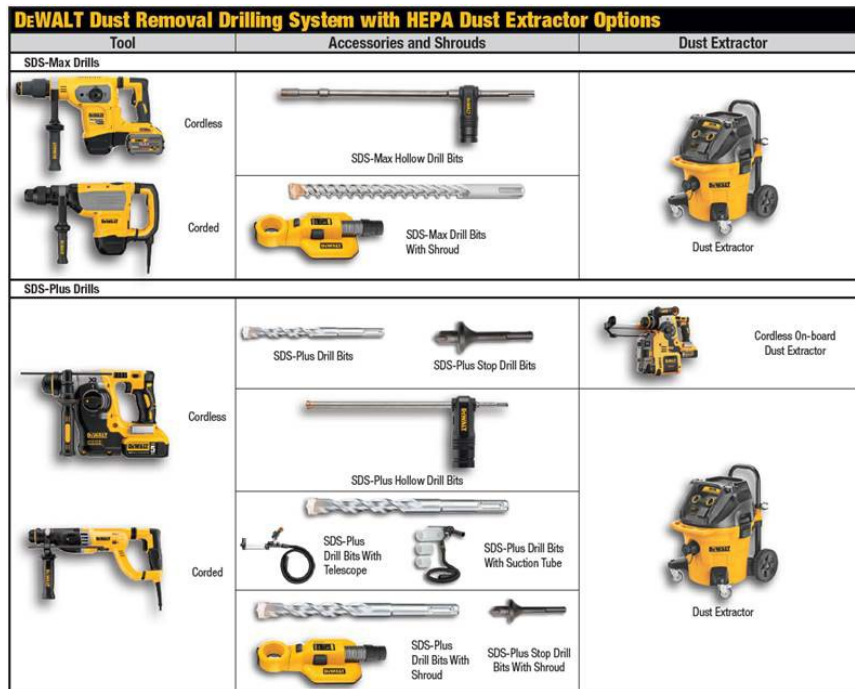

The DEWALT drilling systems shown above collect and remove dust with a HEPA dust extractor during the hole drilling operation in dry base materials using hammer-drills (see step 1 of the manufacturer’s published installation instructions).

**FIGURE A—EXAMPLES DEWALT DUST REMOVAL DRILLING SYSTEMS WITH HEPA DUST EXTRACTORS FOR ILLUSTRATION**

**TABLE 1—DESIGN USE AND REPORT TABLE INDEX FOR POST-INSTALLED ADHESIVE ANCHORS**

DESIGN STRENGTH <sup>1</sup>		THREADED ROD		DEFORMED REINFORCING BAR			
Steel	$N_{sa}, V_{sa}$	<a href="#">Table 4</a>		<a href="#">Table 5</a>			
Concrete	$N_{cb}, N_{cbg}, V_{cb}, V_{cbg}, V_{cp}, V_{cpg}$	<a href="#">Table 6</a>		<a href="#">Table 6</a>			
Bond <sup>2</sup>	$N_a, N_{ag}$	<a href="#">Table 7</a>		<a href="#">Table 7</a>			

CONCRETE TYPE	CONCRETE STATE	THREADED ROD DIAMETER (inch)	REINFORCING BAR SIZE (No.)	DRILLING METHOD <sup>3</sup>	MINIMUM EMBEDMENT	MAXIMUM EMBEDMENT	SEISMIC DESIGN CATEGORIES <sup>4</sup>
Normal-weight and lightweight	Cracked	$3/8, 1/2, 5/8, 3/4, 7/8, 1$ and $1 1/4$	3, 4, 5, 6, 7, 8, 9, 10	Hammer-drill	See <a href="#">Table 7</a>	See <a href="#">Table 7</a>	A through F
	Uncracked	$3/8, 1/2, 5/8, 3/4, 7/8, 1$ and $1 1/4$	3, 4, 5, 6, 7, 8, 9, 10	Hammer-drill	See <a href="#">Table 7</a>	See <a href="#">Table 7</a>	A and B

For SI: 1 inch = 25.4 mm. For pound-inch units: 1 mm = 0.03937 inch.

<sup>1</sup>Reference ACI 318-19 Section 17.5.1 for post-installed adhesive anchors. The controlling strength is decisive from all appropriate failure modes (i.e. steel, concrete, bond) and design assumptions.

<sup>2</sup>See Section 4.1.4 of this report for bond strength determination.

<sup>3</sup>Hammer-drill, i.e. rotary impact drills or rock drills with a carbide drill bit (including hollow drill bits).

<sup>4</sup>See Section 4.1.11 for requirements for seismic design, where applicable.

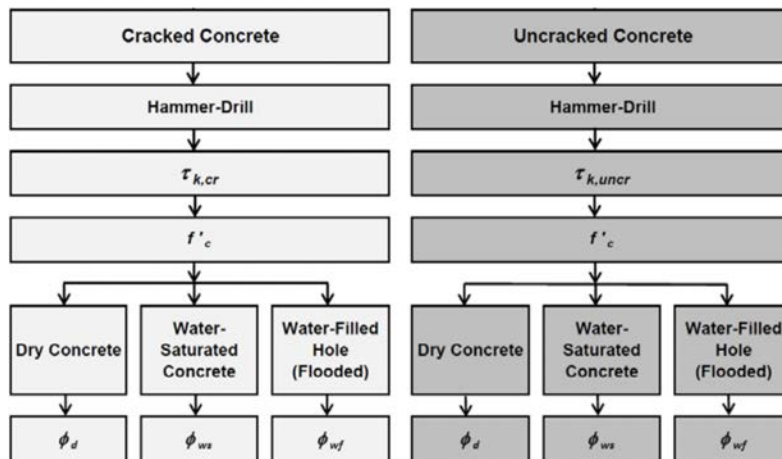

**FIGURE 1—FLOW CHART FOR THE ESTABLISHMENT OF DESIGN BOND STRENGTH**



**TABLE 2—SPECIFICATIONS AND PHYSICAL PROPERTIES OF COMMON THREADED CARBON AND STAINLESS STEEL ROD MATERIALS<sup>1</sup>**

THREADED ROD SPECIFICATION		UNITS	MIN. SPECIFIED ULTIMATE STRENGTH, $f_{uta}$	MIN. SPECIFIED YIELD STRENGTH 0.2 PERCENT OFFSET, $f_{ya}$	$f_{uta}$ — $f_{ya}$	ELONGATION MINIMUM PERCENT <sup>9</sup>	REDUCTION OF AREA MIN. PERCENT	NUT SPECIFICATION <sup>10</sup>
Carbon Steel	ASTM A36 <sup>2</sup> and F1554 <sup>3</sup> Grade 36	psi (MPa)	58,000 (400)	36,000 (248)	1.61	23	40 (50 for A 36)	ASTM A194 / A563 Grade A
	ASTM F1554 <sup>3</sup> Grade 105 and ASTM A193 <sup>4</sup> Grade B7	psi (MPa)	125,000 (862)	105,000 (724)	1.19	15 (16 for A 193)	45 (50 for A 193)	ASTM A194 / A563 Grade DH
	ASTM A449 <sup>5</sup> (3/8 to 1 inch dia.)	psi (MPa)	120,000 (828)	92,000 (635)	1.30	14	35	ASTM A194 / A563 Grade DH
	ASTM A449 <sup>5</sup> (1 1/4 inch dia.)	psi (MPa)	105,000 (720)	81,000 (560)	1.30	14	35	
	ASTM F568M <sup>6</sup> Class 5.8 (equivalent to ISO 898-1)	psi (MPa)	72,500 (500)	58,000 (400)	1.25	10	35	ASTM A563 Grade DH
Stainless Steel	ASTM F593 <sup>7</sup> CW1 (3/8 to 5/8 inch dia.)	psi (MPa)	100,000 (690)	65,000 (450)	1.54	20	- <sup>11</sup>	ASTM F594 Alloy Group 1, 2 or 3
	ASTM F593 <sup>7</sup> CW2 (3/4 to 1 1/4 inch dia.)	psi (MPa)	85,000 (590)	45,000 (310)	1.89	25	- <sup>11</sup>	
	ASTM A193/A193M <sup>8</sup> Grade B8/B8M, Class 1	psi (MPa)	75,000 (515)	30,000 (205)	2.50	30	50	ASTM A194/A194M
	ASTM A193/A193M <sup>8</sup> Grade B8/B8M2, Class 2B	psi (MPa)	95,000 (655)	75,000 (515)	1.27	25	40	

For **SI**: 1 inch = 25.4 mm, 1 psi = 0.006897 MPa. For **pound-inch** units: 1 mm = 0.03937 inch, 1 MPa = 145.0 psi.

<sup>1</sup>Pure50+ epoxy adhesive may be used in conjunction with all grades of continuously threaded carbon or stainless steels (all-thread) that comply with this report and have thread characteristics comparable with ANSI B1.1 UNC Coarse Thread Series or ANSI B1.13M M Profile Metric Thread Series. Tabulated values correspond to anchor diameters included in this report. See Section 3.2.4.3 of this report for ductility of steel anchor elements.

<sup>2</sup>Standard Specification for Carbon Structural Steel.

<sup>3</sup>Standard Specification for Anchor Bolts, Steel, 36, 55, and 105-ksi Yield Strength.

<sup>4</sup>Standard Specification for Alloy-Steel and Stainless Steel Bolting Materials for High Temperature or High Pressure Service and Other Special Purpose Applications.

<sup>5</sup>Standard Specification for Hex Cap Screws, Bolts and Studs, Steel, Heat Treated, 120/105/90 ksi Minimum Tensile Strength, General Use.

<sup>6</sup>Standard Specification for Carbon and Alloy Steel Externally Threaded Metric Fasteners.

<sup>7</sup>Standard Specification for Stainless Steel Bolts, Hex Cap Screws, and Studs.

<sup>8</sup>Standard Standard Specification for Alloy-Steel and Stainless Steel Bolting for High Temperature or High Pressure Service and Other Special Purpose Applications.

<sup>9</sup>Based on 2-inch (50 mm) gauge length except ASTM A193, which are based on a gauge length of 4d and ISO 898, which is based on 5d.

<sup>10</sup>Nuts of other grades and style having specified proof load stress greater than the specified grade and style are also suitable. Nuts must have specified proof load stresses equal to or greater than the minimum tensile strength of the specified threaded rod. Material types of the nuts and washers must be matched to the threaded rods.

<sup>11</sup>Minimum percent reduction of area not reported in the referenced standard.

**TABLE 3—SPECIFICATIONS AND PHYSICAL PROPERTIES OF COMMON STEEL REINFORCING BARS<sup>1</sup>**

REINFORCING SPECIFICATION	UNITS	MINIMUM SPECIFIED ULTIMATE STRENGTH, $f_{uta}$	MINIMUM SPECIFIED YIELD STRENGTH, $f_{ya}$
ASTM A615 <sup>2</sup> , A767 <sup>4</sup> , Grade 80	psi (MPa)	100,000 (690)	80,000 (550)
ASTM A615 <sup>2</sup> , A767 <sup>4</sup> , Grade 75	psi (MPa)	100,000 (690)	75,000 (520)
ASTM A615 <sup>2</sup> , A767 <sup>4</sup> , Grade 60	psi (MPa)	80,000 (550)	60,000 (420)
ASTM A706 <sup>3</sup> , A767 <sup>4</sup> , Grade 60	psi (MPa)	80,000 (550)	60,000 (420)
ASTM A615 <sup>2</sup> , A767 <sup>4</sup> , Grade 40	psi (MPa)	60,000 (420)	40,000 (280)

For **SI**: 1 psi = 0.006897 MPa. For **pound-inch** units: 1 MPa = 145.0 psi.

<sup>1</sup>Adhesive must be used with specified deformed reinforcing bars. Tabulated values correspond to bar sizes included in this report.

<sup>2</sup>Standard Specification for Deformed and Plain Carbon-Steel Bars for Concrete Reinforcement. Grade 40 and Grade 60 bars furnished to specification are considered ductile elements. In accordance with ACI 318-19 Section 17.10.5.3(a)(vi), deformed reinforcing bars meeting this specification used as ductile steel elements to resist earthquake effects shall be limited to reinforcing bars satisfying the requirements of ACI 318-19 Sections 20.2.2.4 and 20.2.2.5. Grade 75 bars furnished to specification are considered brittle elements unless evidence is otherwise shown to the satisfaction of the registered design professional and code official in accordance with Section 3.2.4.3 of this report.

<sup>3</sup>Standard Specification for Low-Alloy Steel Deformed and Plain Bars for Concrete Reinforcement. Bars furnished to specification are considered ductile elements.

<sup>4</sup>Standard Specification for Zinc-Coated (Galvanized) Steel Bars for Concrete Reinforcement. Bars furnished to specification are considered brittle elements unless evidence is otherwise shown to the satisfaction of the registered design professional and code official in accordance with Section 3.2.4.3 of this report.

TABLE 4—STEEL DESIGN INFORMATION FOR THREADED ROD

DESIGN INFORMATION		SYMBOL	UNITS	NOMINAL ROD DIAMETER <sup>1</sup> (inch)						
				3/8	1/2	5/8	3/4	7/8	1	1 1/4
Threaded rod nominal outside diameter		<i>d</i>	inch (mm)	0.375 (9.5)	0.500 (12.7)	0.625 (15.9)	0.750 (19.1)	0.875 (22.2)	1.000 (25.4)	1.250 (31.8)
Threaded rod effective cross-sectional area		<i>A<sub>se</sub></i>	inch <sup>2</sup> (mm <sup>2</sup> )	0.0775 (50)	0.1419 (92)	0.2260 (146)	0.3345 (216)	0.4617 (298)	0.6057 (391)	0.9691 (625)
ASTM A36 and ASTM F1554 Grade 36	Nominal strength as governed by steel strength (for a single anchor)	<i>N<sub>sa</sub></i>	lbf (kN)	4,495 (20.0)	8,230 (36.6)	13,110 (58.3)	19,400 (86.3)	26,780 (119.1)	35,130 (156.3)	56,210 (250.0)
		<i>V<sub>sa</sub></i>	lbf (kN)	2,695 (12.0)	4,940 (22.0)	7,860 (35.0)	11,640 (51.8)	16,070 (71.4)	21,080 (93.8)	33,725 (150.0)
	Reduction factor for seismic shear	$\alpha_{V,seis}$	-	0.80	0.80	0.80	0.80	0.80	0.80	0.80
	Strength reduction factor for tension <sup>2</sup>	$\phi$	-	0.75						
	Strength reduction factor for shear <sup>2</sup>	$\phi$	-	0.65						
ASTM A193 Grade B7 and ASTM F1554 Grade 105	Nominal strength as governed by steel strength (for a single anchor)	<i>N<sub>sa</sub></i>	lbf (kN)	9,685 (43.1)	17,735 (78.9)	28,250 (125.7)	41,810 (186.0)	57,710 (256.7)	75,710 (336.8)	121,135 (538.8)
		<i>V<sub>sa</sub></i>	lbf (kN)	5,815 (25.9)	10,640 (47.3)	16,950 (75.4)	25,085 (111.6)	34,625 (154.0)	45,425 (202.1)	72,680 (323.3)
	Reduction factor for seismic shear	$\alpha_{V,seis}$	-	0.80	0.80	0.80	0.80	0.80	0.80	0.80
	Strength reduction factor for tension <sup>2</sup>	$\phi$	-	0.75						
	Strength reduction factor for shear <sup>2</sup>	$\phi$	-	0.65						
ASTM A449	Nominal strength as governed by steel strength (for a single anchor)	<i>N<sub>sa</sub></i>	lbf (kN)	9,300 (41.4)	17,025 (75.7)	27,120 (120.6)	40,140 (178.5)	55,905 (248.7)	72,685 (323.3)	101,755 (452.6)
		<i>V<sub>sa</sub></i>	lbf (kN)	5,580 (24.8)	10,215 (45.4)	16,270 (72.4)	24,085 (107.1)	33,540 (149.2)	43,610 (194.0)	61,050 (271.6)
	Reduction factor for seismic shear	$\alpha_{V,seis}$	-	0.80	0.80	0.80	0.80	0.80	0.80	0.80
	Strength reduction factor for tension <sup>2</sup>	$\phi$	-	0.75						
	Strength reduction factor for shear <sup>2</sup>	$\phi$	-	0.65						
ASTM F568M <sup>6</sup> Class 5.8 (ISO 898-1)	Nominal strength as governed by steel strength (for a single anchor)	<i>N<sub>sa</sub></i>	lbf (kN)	5,620 (25.0)	10,290 (45.8)	16,385 (72.9)	24,250 (107.9)	33,475 (148.9)	43,915 (195.4)	- <sup>5</sup>
		<i>V<sub>sa</sub></i>	lbf (kN)	3,370 (15.0)	6,175 (27.5)	9,830 (43.7)	14,550 (64.7)	20,085 (89.3)	26,350 (117.2)	- <sup>5</sup>
	Reduction factor for seismic shear	$\alpha_{V,seis}$	-	0.80	0.80	0.80	0.80	0.80	0.80	- <sup>5</sup>
	Strength reduction factor for tension <sup>3</sup>	$\phi$	-	0.65						
	Strength reduction factor for shear <sup>3</sup>	$\phi$	-	0.60						
ASTM F593 CW Stainless (Types 304 and 316)	Nominal strength as governed by steel strength (for a single anchor)	<i>N<sub>sa</sub></i>	lbf (kN)	7,750 (34.5)	14,190 (63.1)	22,600 (100.5)	28,430 (126.5)	39,245 (174.6)	51,485 (229.0)	82,370 (366.4)
		<i>V<sub>sa</sub></i>	lbf (kN)	4,650 (20.7)	8,515 (37.9)	13,560 (60.3)	17,060 (75.9)	23,545 (104.7)	30,890 (137.4)	49,425 (219.8)
	Reduction factor for seismic shear	$\alpha_{V,seis}$	-	0.70	0.70	0.80	0.80	0.80	0.80	0.80
	Strength reduction factor for tension <sup>3</sup>	$\phi$	-	0.65						
	Strength reduction factor for shear <sup>3</sup>	$\phi$	-	0.60						
ASTM A193 Grade B8/B8M, Class 1 Stainless (Types 304 and 316)	Nominal strength as governed by steel strength (for a single anchor) <sup>4</sup>	<i>N<sub>sa</sub></i>	lbf (kN)	4,420 (19.7)	8,090 (36.0)	12,880 (57.3)	19,065 (84.8)	26,315 (117.1)	34,525 (153.6)	55,240 (245.7)
		<i>V<sub>sa</sub></i>	lbf (kN)	2,650 (11.8)	4,855 (21.6)	7,730 (34.4)	11,440 (50.9)	15,790 (70.2)	20,715 (92.1)	33,145 (147.4)
	Reduction factor for seismic shear	$\alpha_{V,seis}$	-	0.70	0.70	0.80	0.80	0.80	0.80	0.80
	Strength reduction factor for tension <sup>2</sup>	$\phi$	-	0.75						
	Strength reduction factor for shear <sup>2</sup>	$\phi$	-	0.65						
ASTM A193 Grade B8/B8M2, Class 2B Stainless (Types 304 and 316)	Nominal strength as governed by steel strength (for a single anchor)	<i>N<sub>sa</sub></i>	lbf (kN)	7,365 (32.8)	13,480 (60.0)	21,470 (95.5)	31,775 (141.3)	43,860 (195.1)	57,545 (256.0)	92,065 (409.5)
		<i>V<sub>sa</sub></i>	lbf (kN)	4,420 (19.7)	8,085 (36.0)	12,880 (57.3)	19,065 (84.8)	26,315 (117.1)	34,525 (153.6)	55,240 (245.7)
	Reduction factor for seismic shear	$\alpha_{V,seis}$	-	0.70	0.70	0.80	0.80	0.80	0.80	0.80
	Strength reduction factor for tension <sup>2</sup>	$\phi$	-	0.75						
	Strength reduction factor for shear <sup>2</sup>	$\phi$	-	0.65						

For **SI**: 1 inch = 25.4 mm, 1 lbf = 4.448 N. For **pound-inch** units: 1 mm = 0.03937 inches, 1 N = 0.2248 lbf.

<sup>1</sup>Values provided for steel element material types are based on minimum specified strengths and calculated in accordance with ACI 318-19 Eq. 17.6.1.2 and Eq. 17.7.1.2(b) except where noted. Nuts and washers must be appropriate for the rod. See Table 2 for nut specifications.

<sup>2</sup>The strength reduction factor applies when the load combinations from the IBC or ACI 318-19 are used and the requirements of ACI 318-19 Section 17.5.3 are met. Values correspond to ductile steel elements.

<sup>3</sup>The strength reduction factor applies when the load combinations from the IBC or ACI 318-19 are used and the requirements of ACI 318-19 Section 17.5.3 are met. Values correspond to brittle steel elements.

<sup>4</sup>In accordance with ACI 318-19 Eq. 17.6.1.2 and Eq. 17.7.1.2, the calculated values for nominal tension and shear strength for ASTM A193 Grade B8/B8M Class 1 stainless steel threaded rods are based on limiting the specified tensile strength of the anchor steel to 1.9 $f_y$  or 57,000 psi (393 MPa).

<sup>5</sup>The referenced standard includes rod diameters up to and including 1-inch (24 mm).

TABLE 5—STEEL DESIGN INFORMATION FOR REINFORCING BARS

DESIGN INFORMATION		SYMBOL	UNITS	NOMINAL REINFORCING BAR SIZE (REBAR) <sup>1</sup>							
				No. 3	No. 4	No. 5	No. 6	No. 7	No. 8	No. 9	No. 10
Rebar nominal outside diameter		<i>d</i>	inch (mm)	0.375 (9.5)	0.500 (12.7)	0.625 (15.9)	0.750 (19.1)	0.875 (22.2)	1.000 (25.4)	1.125 (28.7)	1.250 (32.3)
Rebar effective cross-sectional area		<i>A<sub>se</sub></i>	inch <sup>2</sup> (mm <sup>2</sup> )	0.110 (71.0)	0.200 (129.0)	0.310 (200.0)	0.440 (283.9)	0.600 (387.1)	0.790 (509.7)	1.000 (645.2)	1.270 (819.4)
ASTM A615 Grade 80	Nominal strength as governed by steel strength (for a single anchor)	<i>N<sub>sa</sub></i>	lbf (kN)	11,000 (48.9)	20,000 (89.0)	31,000 (137.9)	44,000 (195.7)	60,000 (266.9)	79,000 (351.4)	100,000 (444.8)	127,000 (564.9)
		<i>V<sub>sa</sub></i>	lbf (kN)	6,600 (29.4)	12,000 (53.4)	18,600 (82.7)	26,400 (117.4)	36,000 (160.1)	47,400 (210.8)	60,000 (266.9)	76,200 (338.9)
	Reduction factor for seismic shear	$\alpha_{V,seis}$	-	0.70	0.70	0.80	0.80	0.80	0.80	0.80	0.80
	Strength reduction factor for tension <sup>3</sup>	$\phi$	-	0.65							
	Strength reduction factor for shear <sup>3</sup>	$\phi$	-	0.60							
ASTM A615 Grade 75	Nominal strength as governed by steel strength (for a single anchor)	<i>N<sub>sa</sub></i>	lbf (kN)	11,000 (48.9)	20,000 (89.0)	31,000 (137.9)	44,000 (195.7)	60,000 (266.9)	79,000 (351.4)	100,000 (444.8)	127,000 (564.9)
		<i>V<sub>sa</sub></i>	lbf (kN)	6,600 (29.4)	12,000 (53.4)	18,600 (82.7)	26,400 (117.4)	36,000 (160.1)	47,400 (210.8)	60,000 (266.9)	76,200 (338.9)
	Reduction factor for seismic shear	$\alpha_{V,seis}$	-	0.70	0.70	0.80	0.80	0.80	0.80	0.80	0.80
	Strength reduction factor for tension <sup>3</sup>	$\phi$	-	0.65							
	Strength reduction factor for shear <sup>3</sup>	$\phi$	-	0.60							
ASTM A615 Grade 60	Nominal strength as governed by steel strength (for a single anchor)	<i>N<sub>sa</sub></i>	lbf (kN)	8,800 (39.1)	16,000 (71.2)	24,800 (110.3)	35,200 (156.6)	48,000 (213.5)	63,200 (281.1)	80,000 (355.9)	101,600 (452.0)
		<i>V<sub>sa</sub></i>	lbf (kN)	5,280 (23.5)	9,600 (42.7)	14,880 (66.2)	21,120 (94.0)	28,800 (128.1)	37,920 (168.7)	48,000 (213.5)	60,960 (271.2)
	Reduction factor for seismic shear	$\alpha_{V,seis}$	-	0.70	0.70	0.80	0.80	0.80	0.80	0.80	0.80
	Strength reduction factor for tension <sup>3</sup>	$\phi$	-	0.65							
	Strength reduction factor for shear <sup>3</sup>	$\phi$	-	0.60							
ASTM A706 Grade 60	Nominal strength as governed by steel strength (for a single anchor)	<i>N<sub>sa</sub></i>	lbf (kN)	8,800 (39.1)	16,000 (71.2)	24,800 (110.3)	35,200 (156.6)	48,000 (213.5)	63,200 (281.1)	80,000 (355.9)	101,600 (452.0)
		<i>V<sub>sa</sub></i>	lbf (kN)	5,280 (23.5)	9,600 (42.7)	14,880 (66.2)	21,120 (94.0)	28,800 (128.1)	37,920 (168.7)	48,000 (213.5)	60,960 (271.2)
	Reduction factor for seismic shear	$\alpha_{V,seis}$	-	0.70	0.70	0.80	0.80	0.80	0.80	0.80	0.80
	Strength reduction factor for tension <sup>2</sup>	$\phi$	-	0.75							
	Strength reduction factor for shear <sup>2</sup>	$\phi$	-	0.65							
ASTM A615 Grade 40	Nominal strength as governed by steel strength (for a single anchor)	<i>N<sub>sa</sub></i>	lbf (kN)	6,600 (29.4)	12,000 (53.4)	18,600 (82.7)	26,400 (117.4)	In accordance with ASTM A615, Grade 40 bars are furnished only in sizes No. 3 through No. 6			
		<i>V<sub>sa</sub></i>	lbf (kN)	3,960 (17.6)	7,200 (32.0)	11,160 (49.6)	15,840 (70.5)				
	Reduction factor for seismic shear	$\alpha_{V,seis}$	-	0.70	0.70	0.80	0.80				
	Strength reduction factor for tension <sup>3</sup>	$\phi$	-	0.65							
	Strength reduction factor for shear <sup>3</sup>	$\phi$	-	0.60							

For SI: 1 inch = 25.4 mm, 1 lbf = 4.448 N. For pound-inch units: 1 mm = 0.03937 inches, 1 N = 0.2248 lbf.

<sup>1</sup>Values provided for reinforcing bar material types based on minimum specified strengths and calculated in accordance with ACI 318-19 Eq. 17.6.1.2 and Eq. 17.7.1.2(b).

<sup>2</sup>The strength reduction factor applies when the load combinations from the IBC or ACI 318-19 are used and the requirements of ACI 318-19 Section 17.5.3 are met. Values correspond to ductile steel elements. In accordance with ACI 318-19 Section 17.10.5.3(a)(vi), deformed reinforcing bars meeting this specification used as ductile steel elements to resist earthquake effects shall be limited to reinforcing bars satisfying the requirements of ACI 318-19 Sections 20.2.2.4 and 20.2.2.5.

<sup>3</sup>The strength reduction factor applies when the load combinations from the IBC or ACI 318-19 are used and the requirements of ACI 318-19 Section 17.5.3 are met. Values correspond to brittle steel elements.

TABLE 6—CONCRETE BREAKOUT DESIGN INFORMATION FOR THREADED ROD AND REINFORCING BARS<sup>1</sup>

DESIGN INFORMATION	SYMBOL	UNITS	NOMINAL ROD DIAMETER (inch) / REINFORCING BAR SIZE							
			<sup>3</sup> / <sub>8</sub> or #3	<sup>1</sup> / <sub>2</sub> or #4	<sup>5</sup> / <sub>8</sub> or #5	<sup>3</sup> / <sub>4</sub> or #6	<sup>7</sup> / <sub>8</sub> or #7	1 or #8	#9	<sup>1</sup> / <sub>4</sub> or #10
Effectiveness factor for cracked concrete	$k_{c,cr}$	- (SI)	17 (7.1)							
Effectiveness factor for uncracked concrete	$k_{c,uncr}$	- (SI)	24 (10.0)							
Minimum embedment	$h_{ef,min}$	inch (mm)	<sup>2</sup> / <sub>8</sub> (60)	<sup>2</sup> / <sub>4</sub> (70)	<sup>3</sup> / <sub>8</sub> (79)	<sup>3</sup> / <sub>2</sub> (89)	<sup>3</sup> / <sub>2</sub> (89)	4 (102)	<sup>4</sup> / <sub>2</sub> (114)	5 (127)
Maximum embedment	$h_{ef,max}$	inch (mm)	<sup>7</sup> / <sub>2</sub> (191)	10 (254)	<sup>12</sup> / <sub>2</sub> (318)	15 (381)	<sup>17</sup> / <sub>2</sub> (445)	20 (508)	<sup>22</sup> / <sub>2</sub> (572)	25 (635)
Minimum anchor spacing	$s_{min}$	inch (mm)	<sup>1</sup> / <sub>8</sub> (48)	<sup>2</sup> / <sub>2</sub> (64)	<sup>3</sup> / <sub>8</sub> (79)	<sup>3</sup> / <sub>4</sub> (95)	<sup>4</sup> / <sub>8</sub> (111)	5 (127)	<sup>5</sup> / <sub>8</sub> (143)	<sup>6</sup> / <sub>4</sub> (159)
Minimum edge distance	$c_{min}$	inch (mm)	5d where d is nominal outside diameter of the anchor; or see Section 4.1.9 of this report for design with reduced minimum edge distances down to the following values:							
			<sup>1</sup> / <sub>4</sub> (45)	<sup>1</sup> / <sub>4</sub> (45)	<sup>1</sup> / <sub>4</sub> (45)	<sup>1</sup> / <sub>4</sub> (45)	<sup>1</sup> / <sub>4</sub> (45)	<sup>1</sup> / <sub>4</sub> (45)	<sup>2</sup> / <sub>4</sub> (70)	<sup>2</sup> / <sub>4</sub> (70)
Minimum member thickness	$h_{min}$	inch (mm)	$h_{ef} + 1\frac{1}{4}$ ( $h_{ef} + 30$ )		$h_{ef} + 2d_o$ where $d_o$ is hole diameter; for installation parameters see Table 8 of this report					
Critical edge distance—splitting (for uncracked concrete only)	$c_{ac}$	inch (mm)	See Section 4.1.10 of this report							
Strength reduction factor for tension, concrete failure modes, Condition B, (supplemental reinforcement not present) <sup>2</sup> (concrete breakout)	$\phi$	-	0.65							
Strength reduction factor for shear, concrete failure modes, Condition B (supplemental reinforcement not present) <sup>2</sup> (concrete breakout and pryout)	$\phi$	-	0.70							

For **SI**: 1 inch = 25.4 mm, 1 lbf = 4.448 N. For **pound-inch** units: 1 mm = 0.03937 inch, 1 N = 0.2248 lbf.

<sup>1</sup>Additional setting information is described in Table 8 and in the installation instructions, Figure 3 of this report.

<sup>2</sup>The strength reduction factor applies when the load combinations from the IBC or ACI 318-19 are used and the requirements of ACI 318-19 Section 17.5.3.

TABLE 7—BOND STRENGTH DESIGN INFORMATION FOR THREADED RODS AND REINFORCING BARS<sup>1,2</sup>

DESIGN INFORMATION		SYMBOL	UNITS	NOMINAL ROD DIAMETER (inch) / REINFORCING BAR SIZE							
				<sup>3</sup> / <sub>8</sub> or #3	<sup>1</sup> / <sub>2</sub> or #4	<sup>5</sup> / <sub>8</sub> or #5	<sup>3</sup> / <sub>4</sub> or #6	<sup>7</sup> / <sub>8</sub> or #7	1 or #8	#9	<sup>1</sup> / <sub>4</sub> or #10
Minimum embedment		$h_{ef,min}$	inch (mm)	<sup>2</sup> / <sub>8</sub> (60)	<sup>2</sup> / <sub>4</sub> (70)	<sup>3</sup> / <sub>8</sub> (79)	<sup>3</sup> / <sub>2</sub> (89)	<sup>3</sup> / <sub>2</sub> (89)	4 (102)	<sup>4</sup> / <sub>2</sub> (114)	5 (127)
Maximum embedment		$h_{ef,max}$	inch (mm)	<sup>7</sup> / <sub>2</sub> (191)	10 (254)	<sup>12</sup> / <sub>2</sub> (318)	15 (381)	<sup>17</sup> / <sub>2</sub> (445)	20 (508)	<sup>22</sup> / <sub>2</sub> (572)	25 (635)
110°F (43°C) Maximum long-term service temperature; 140°F (60°C) maximum short-term service temperature <sup>3,5</sup>	Characteristic bond strength in cracked concrete <sup>6,9</sup>	$\tau_{k,cr}$	psi (N/mm <sup>2</sup> )	684 (4.7)	658 (4.5)	632 (4.4)	608 (4.2)	585 (4.0)	562 (3.9)	562 (3.9)	562 (3.9)
	Characteristic bond strength in cracked concrete, short-term loading only <sup>9</sup>			752 (5.2)	724 (5.0)	695 (4.8)	668 (4.6)	643 (4.4)	618 (4.3)	618 (4.3)	618 (4.3)
	Characteristic bond strength in uncracked concrete <sup>6,8</sup>	$\tau_{k,uncr}$	psi (N/mm <sup>2</sup> )	1,444 (10.0)	1,389 (9.6)	1,335 (9.2)	1,283 (8.8)	1,234 (8.5)	1,184 (8.2)	1,184 (8.2)	1,184 (8.2)
	Characteristic bond strength in uncracked concrete short-term loading only <sup>8</sup>			1,588 (10.9)	1,528 (10.5)	1,469 (10.1)	1,411 (9.7)	1,357 (9.4)	1,303 (9.0)	1,303 (9.0)	1,303 (9.0)
110°F (43°C) Maximum long-term service temperature; 176°F (80°C) maximum short-term service temperature <sup>4,5</sup>	Characteristic bond strength in cracked concrete <sup>6,9</sup>	$\tau_{k,cr}$	psi (N/mm <sup>2</sup> )	475 (3.3)	457 (3.2)	439 (3.0)	422 (2.9)	406 (2.8)	390 (2.7)	390 (2.7)	390 (2.7)
	Characteristic bond strength in cracked concrete, short-term loading only <sup>9</sup>			523 (3.6)	503 (3.5)	483 (3.3)	464 (3.2)	447 (3.1)	429 (3.0)	429 (3.0)	429 (3.0)
	Characteristic bond strength in uncracked concrete <sup>6,8</sup>	$\tau_{k,uncr}$	psi (N/mm <sup>2</sup> )	1,024 (7.1)	985 (6.8)	947 (6.5)	910 (6.3)	875 (6.0)	840 (5.8)	840 (5.8)	840 (5.8)
	Characteristic bond strength in uncracked concrete short-term loading only <sup>8</sup>			1,126 (7.8)	1,084 (7.5)	1,042 (7.2)	1,001 (6.9)	963 (6.6)	924 (6.4)	924 (6.4)	924 (6.4)
Permissible installation conditions <sup>6</sup>	Dry concrete	Anchor Category	-	1							
		$\phi_d$	-	0.65							
	Water-saturated concrete, Water-filled hole (flooded)	Anchor Category	-	2							
		$\phi_{ws}$ , $\phi_{wf}$	-	0.55							
Reduction factor for seismic tension <sup>9</sup>		$\alpha_{N,seis}$	-	1.0							

For SI: 1 inch = 25.4 mm, 1 psi = 0.006894 MPa. For pound-inch units: 1 mm = 0.03937 inch, 1 MPa = 145.0 psi.

<sup>1</sup>Bond strength values correspond to normal-weight concrete compressive strength  $f_c = 2,500$  psi (17.2 MPa). For concrete compressive strength,  $f_c$  between 2,500 psi and 8,000 psi (17.2 MPa and 55.2 MPa), the tabulated characteristic bond strength may be increased by a factor of  $(f_c / 2,500)^{0.23}$  [For SI:  $(f_c / 17.2)^{0.23}$ ]. See Section 4.1.4 of this report for bond strength determination.

<sup>2</sup>The modification factor for bond strength of adhesive anchors in lightweight concrete shall be taken as given in ACI 318-19 Section 17.2.4.

<sup>3</sup>Long-term and short-term temperatures meet the requirements of Section 8.5 of ACI 355.4 and Table 8.1, Temperature Category B.

<sup>4</sup>Long-term and short-term temperatures meet the requirements of Section 8.5 of ACI 355.4 and Table 8.1, Temperature Category A.

<sup>5</sup>Short-term elevated concrete temperatures are those that occur over brief intervals, e.g. as a result of diurnal cycling. Long-term concrete temperatures are roughly constant over significant periods of time.

<sup>6</sup>Characteristic bond strengths are for sustained loads including dead and live loads.

<sup>7</sup>Permissible installation conditions include dry concrete, water-saturated concrete and water-filled holes. Water-filled holes include applications in dry or water-saturated concrete where the drilled holes contain standing water during anchor installation. For installation instructions see Figure 3 of this report.

<sup>8</sup>Bond strength values for uncracked concrete are applicable for structures assigned to Seismic Design Categories A and B only.

<sup>9</sup>For structures assigned to Seismic Design Categories C, D, E or F, the tabulated bond strength values for cracked concrete do not require an additional reduction factor applied for seismic tension ( $\alpha_{N,seis} = 1.0$ ), where seismic design is applicable. See Section 4.1.11 of this report for requirements for seismic design.



TABLE 8—INSTALLATION PARAMETERS FOR THREADED ROD AND REINFORCING BARS

PARAMETER	SYMBOL	UNITS	FRACTIONAL NOMINAL ROD DIAMETER (inch) / REINFORCING BAR SIZE									
			<sup>3</sup> / <sub>8</sub> or #3	<sup>1</sup> / <sub>2</sub>	#4	<sup>5</sup> / <sub>8</sub> or #5	<sup>3</sup> / <sub>4</sub> or #6	<sup>7</sup> / <sub>8</sub> or #7	1 or #8	#9	1 <sup>1</sup> / <sub>4</sub>	#10
Threaded rod outside diameter	<i>d</i>	inch (mm)	0.375 (9.5)	0.500 (12.7)	0.625 (15.9)	0.750 (19.1)	0.875 (22.2)	1.000 (25.4)	-	1.250 (31.8)	-	
Rebar nominal outside diameter	<i>d</i>	inch (mm)	0.375 (9.5)	0.500 (12.7)	0.625 (15.9)	0.750 (19.1)	0.875 (22.2)	1.000 (25.4)	1.125 (28.7)	-	1.250 (31.8)	
Carbide drill bit nominal size	<i>d<sub>o</sub></i> ( <i>d<sub>bit</sub></i> )	inch	<sup>7</sup> / <sub>16</sub>	<sup>9</sup> / <sub>16</sub>	<sup>5</sup> / <sub>8</sub>	<sup>11</sup> / <sub>16</sub> or <sup>3</sup> / <sub>4</sub> <sup>5</sup>	<sup>7</sup> / <sub>8</sub>	1	1 <sup>1</sup> / <sub>8</sub>	1 <sup>3</sup> / <sub>8</sub>	1 <sup>3</sup> / <sub>8</sub>	1 <sup>1</sup> / <sub>2</sub>
Minimum embedment	<i>h<sub>ef,min</sub></i>	inch (mm)	<sup>2</sup> / <sub>8</sub> (60)	<sup>2</sup> / <sub>4</sub> (70)	<sup>3</sup> / <sub>8</sub> (79)	<sup>3</sup> / <sub>2</sub> (89)	<sup>3</sup> / <sub>2</sub> (89)	4 (102)	4 <sup>1</sup> / <sub>2</sub> (114)	5 (127)	5 (127)	
Maximum embedment	<i>h<sub>ef,max</sub></i>	inch (mm)	<sup>7</sup> / <sub>2</sub> (191)	10 (254)	12 <sup>1</sup> / <sub>2</sub> (318)	15 (381)	17 <sup>1</sup> / <sub>2</sub> (445)	20 (508)	22 <sup>1</sup> / <sub>2</sub> (572)	25 (635)	25 (635)	
Minimum member thickness	<i>h<sub>min</sub></i>	inch (mm)	<i>h<sub>ef</sub></i> + 1 <sup>1</sup> / <sub>4</sub> ( <i>h<sub>ef</sub></i> + 30)			<i>h<sub>ef</sub></i> + 2 <i>d<sub>o</sub></i>						
Minimum anchor spacing	<i>S<sub>min</sub></i>	inch (mm)	1 <sup>7</sup> / <sub>8</sub> (48)	2 <sup>1</sup> / <sub>2</sub> (64)	3 <sup>1</sup> / <sub>8</sub> (79)	3 <sup>3</sup> / <sub>4</sub> (95)	4 <sup>3</sup> / <sub>8</sub> (111)	5 (127)	5 <sup>5</sup> / <sub>8</sub> (143)	6 <sup>1</sup> / <sub>4</sub> (159)	6 <sup>1</sup> / <sub>4</sub> (159)	
Minimum edge distance	<i>C<sub>min</sub></i>	inch (mm)	1 <sup>7</sup> / <sub>8</sub> (48)	2 <sup>1</sup> / <sub>2</sub> (64)	3 <sup>1</sup> / <sub>8</sub> (79)	3 <sup>3</sup> / <sub>4</sub> (95)	4 <sup>3</sup> / <sub>8</sub> (111)	5 (127)	5 <sup>5</sup> / <sub>8</sub> (143)	6 <sup>1</sup> / <sub>4</sub> (159)	6 <sup>1</sup> / <sub>4</sub> (159)	
Max. torque <sup>1</sup>	<i>T<sub>max</sub></i>	ft-lbs	15	30	60	105	125	165	200	280	280	
Max. torque <sup>1,2</sup> (low strength rods)	<i>T<sub>max</sub></i>	ft-lbs	5	20	40	60	100	165	-	280	-	
Minimum edge distance, reduced <sup>3</sup>	<i>C<sub>min,red</sub></i>	inch (mm)	1 <sup>3</sup> / <sub>4</sub> (45)	1 <sup>3</sup> / <sub>4</sub> (45)	1 <sup>3</sup> / <sub>4</sub> (45)	1 <sup>3</sup> / <sub>4</sub> (45)	1 <sup>3</sup> / <sub>4</sub> (45)	1 <sup>3</sup> / <sub>4</sub> (45)	2 <sup>3</sup> / <sub>4</sub> (70)	2 <sup>3</sup> / <sub>4</sub> (70)	2 <sup>3</sup> / <sub>4</sub> (70)	
Max. torque, reduced <sup>1</sup>	<i>T<sub>max,red</sub></i>	ft-lbs	7 [5] <sup>4</sup>	14	27	47	56	74	90	126	126	

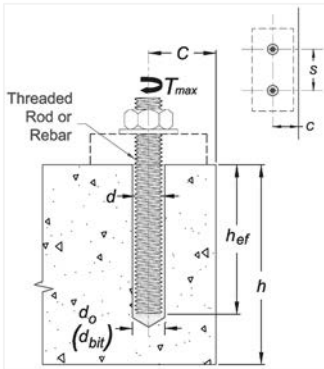

For **pound-inch** units: 1 mm = 0.03937 inch, 1 N-m = 0.7375 ft-lbf. For **SI**: 1 inch = 25.4 mm, 1 ft-lbf = 1.356 N-m.

<sup>1</sup>Torque may not be applied to the anchors until the full cure time of the adhesive has been achieved.

<sup>2</sup>These torque values apply to ASTM A36 / F1554 Grade 36 carbon steel threaded rods and ASTM A193 Grade B8/B8M (Class 1) stainless steel threaded rods.

<sup>3</sup>See Section 4.1.9 of this report for requirements of anchors installed at reduced edge distances.

<sup>4</sup>This torque value applies to ASTM A193 Grade B8/B8M (Class 1) stainless steel threaded rod only.

<sup>5</sup>Either drill bit size is acceptable for this threaded rod diameter and rebar size. See MPII for additional details.



FIGURE 2—PURE50+ EPOXY ADHESIVE ANCHOR SYSTEM INCLUDING TYPICAL STEEL ANCHOR ELEMENTS

TABLE 9—EXAMPLE OF PURE50+ EPOXY ADHESIVE ANCHOR ALLOWABLE STRESS DESIGN (ASD) VALUES FOR ILLUSTRATIVE PURPOSES 1,2,3,4,6,9,10,13,14,16

NOMINAL ANCHOR ROD DIAMETER OR REBAR SIZE, <i>d</i> (inch) / (No.)	EFFECTIVE EMBED. <sup>5</sup> <i>h<sub>ef</sub></i> (inches)	CONCRETE STRENGTH <sup>12</sup> <i>f<sub>c</sub></i> (psi)	EFFECTIVE-NESS FACTOR FOR UNCRACKED CONCRETE <i>K<sub>uncr</sub></i>	CHARACTERISTIC BOND STRENGTH <i>τ<sub>k,uncr</sub></i> (psi)		NOMINAL STRENGTH IN TENSION <i>N<sub>n</sub></i> (pounds)		STRENGTH REDUCTON FACTOR <i>φ</i> <sup>15</sup>		ALLOWABLE TENSION LOAD <sup>11</sup> <i>φ N<sub>n</sub> / α</i> (pounds)	
				110°F LT, 140°F ST <sup>7</sup>	110°F LT, 176°F ST <sup>8</sup>	110°F LT, 140°F ST <sup>7</sup>	110°F LT, 176°F ST <sup>8</sup>	110°F LT, 140°F ST <sup>7</sup>	110°F LT, 176°F ST <sup>8</sup>	110°F LT, 140°F ST <sup>7</sup>	110°F LT, 176°F ST <sup>8</sup>
<b>ASTM A193 Grade B7 Threaded Rod</b>											
3/8	2 3/8	2,500	24	1,444	1,024	4,040	2,865	0.65 (bond)	0.65 (bond)	1,775	1,255
	7 1/2	2,500	24	1,444	1,024	9,688	9,048	0.75 (steel)	0.65 (bond)	4,910	3,975
1/2	2 3/4	2,500	24	1,389	985	5,472	4,255	0.65 (conc)	0.65 (bond)	2,400	1,870
	10	2,500	24	1,389	985	17,738	15,472	0.75 (steel)	0.65 (bond)	8,990	6,795
5/8	3 1/8	2,500	24	1,335	947	6,629	5,811	0.65 (conc)	0.65 (bond)	2,910	2,550
	12 1/2	2,500	24	1,335	947	28,250	23,243	0.75 (steel)	0.65 (bond)	14,320	10,210
3/4	3 1/2	2,500	24	1,283	910	7,857	7,504	0.65 (conc)	0.65 (bond)	3,450	3,295
	15	2,500	24	1,283	910	45,345	32,162	0.65 (bond)	0.65 (bond)	19,915	14,125
7/8	3 1/2	2,500	24	1,234	875	7,857	7,857	0.65 (conc)	0.65 (conc)	3,450	3,450
	17 1/2	2,500	24	1,234	875	59,362	42,092	0.65 (bond)	0.65 (bond)	26,070	18,485
1	4	2,500	24	1,184	840	9,600	9,600	0.65 (conc)	0.65 (conc)	4,215	4,215
	20	2,500	24	1,184	840	74,393	52,779	0.65 (bond)	0.65 (bond)	32,670	23,180
1 1/4	5	2,500	24	1,184	840	13,416	13,416	0.65 (conc)	0.65 (conc)	5,890	5,890
	25	2,500	24	1,184	840	116,239	82,467	0.65 (bond)	0.65 (bond)	51,050	36,220
<b>ASTM A706 Grade 60 Reinforcing Bar</b>											
3	2 3/8	2,500	24	1,444	1,024	4,040	2,865	0.65 (bond)	0.65 (bond)	1,775	1,255
	7 1/2	2,500	24	1,444	1,024	8,800	9,048	0.75 (steel)	0.65 (bond)	4,460	3,975
4	2 3/4	2,500	24	1,389	985	5,472	4,255	0.65 (conc)	0.65 (bond)	2,400	1,870
	10	2,500	24	1,389	985	16,000	15,472	0.75 (steel)	0.55 (bond)	8,110	6,795
5	3 1/8	2,500	24	1,335	947	6,629	5,811	0.65 (conc)	0.65 (bond)	2,550	2,550
	12 1/2	2,500	24	1,335	947	24,800	23,243	0.65 (steel)	0.65 (bond)	12,570	10,210
6	3 1/2	2,500	24	1,283	910	7,857	7,504	0.65 (conc)	0.65 (bond)	3,295	3,295
	15	2,500	24	1,283	910	35,200	32,162	0.75 (steel)	0.65 (bond)	17,840	14,125
7	3 1/2	2,500	24	1,234	875	7,857	7,857	0.65 (conc)	0.65 (conc)	3,450	3,450
	17 1/2	2,500	24	1,234	875	48,000	42,092	0.75 (steel)	0.65 (bond)	24,325	18,485
8	4	2,500	24	1,184	840	9,600	9,600	0.65 (conc)	0.65 (conc)	4,215	4,215
	20	2,500	24	1,184	840	63,200	52,779	0.75 (steel)	0.65 (bond)	32,025	23,180
9	4 1/2	2,500	24	1,184	840	11,455	11,455	0.65 (conc)	0.65 (conc)	5,030	5,030
	22 1/2	2,500	24	1,184	840	80,000	66,798	0.75 (steel)	0.65 (bond)	40,540	29,340
10	5	2,500	24	1,184	840	13,146	13,146	0.65 (conc)	0.65 (conc)	5,890	5,890
	25	2,500	24	1,184	840	116,239	82,467	0.65 (bond)	0.65 (bond)	51,050	36,220

For **SI**: 1 inch = 25.4 mm, 1 lbf = 4.448 N, 1 psi = 0.006894 MPa. For **pound-inch** units: 1 mm = 0.03937 inch, 1 N = 0.2248 lbf, 1 MPa = 145.0 psi.

<sup>1</sup>Single anchor with static tension load only; ASTM A193 Grade B7 threaded rod and ASTM A706 Grade 60 reinforcing bar.

<sup>2</sup>Vertical downward installation direction.

<sup>3</sup>Special inspection interval = Periodic.

<sup>4</sup>Installation temperature = 50°F (10°C) to 104°F (40°C) for base material; 50°F (10°C) to 104°F (40°C) for cartridge adhesive.

<sup>5</sup>Embedment = *h<sub>ef,min</sub>* and *h<sub>ef,max</sub>* for each diameter.

<sup>6</sup>Concrete determined to remain uncracked for the life of the anchorage.

<sup>7</sup>Long-term service temperature = 110°F (43°C), short-term service temperature = 140°F (60°C).

<sup>8</sup>Long-term service temperature = 110°F (43°C), short-term service temperature = 176°F (80°C).

<sup>9</sup>Load combinations are based on ACI 318-19 Section 5.3 with no seismic loading considered.

<sup>10</sup>Thirty percent (30%) dead load and seventy percent (70%) live load; controlling load combination 1.2D + 1.6L.

<sup>11</sup>Calculation of weighted average for the conversion factor,  $\alpha = 1.2(0.3) + 1.6(0.7) = 1.48$ .

<sup>12</sup>*f<sub>c</sub>* = 2,500 psi compressive strength (normal-weight concrete).

<sup>13</sup>*C<sub>at</sub>* = *C<sub>az</sub>* > *C<sub>ac</sub>*.

<sup>14</sup>*h* ≥ *h<sub>min</sub>*.

<sup>15</sup>Strength reduction factor from controlling nominal strength in tension [i.e. steel, concrete (conc), bond] decisive from design assumptions.

<sup>16</sup>Hammer-drilled holes in dry concrete.

**TABLE 10— APPLICABLE SECTIONS OF THE IBC CODE UNDER EACH EDITION OF THE IBC**

2024 IBC	2021 IBC	2018 IBC	2015 IBC
Section 1605.1		Section 1605.2 or 1605.3	
	Section 1705.1.1		
	Table 1705.3		
	Section 1705		
	Section 1901.3		
	Section 1903		
	Section 1905		
Section 1905.7		Section 1905.1.8	

**TABLE 11— APPLICABLE SECTIONS OF ACI 318 UNDER EACH EDITION OF THE IBC**

2024 IBC	2021 IBC	2018 IBC	2015 IBC
<b>ACI 318-19</b>		<b>ACI 318-14</b>	
2.3		2.3	
5.3		5.3	
Chapter 17		Chapter 17	
17.2.4		17.2.6	
17.3.1		17.2.7	
17.5.1		17.3.1.1	
17.5.1.2		17.3.1	
17.5.3		17.3.3	
17.6.1.2		17.4.1.2	
Eq. 17.6.1.2		Eq. 17.4.1.2	
17.6.2		17.4.2	
17.6.2.2		17.4.2.2	
17.6.2.5		17.4.2.6	
17.6.5		17.4.5	
Eq 17.6.5.1.2b		Eq 17.4.5.1d	
Eq 17.6.5.2.1		Eq 17.4.5.2	
17.6.5.5		17.4.5.5	
Eq. 17.6.5.5.1b		Eq. 17.4.5.5b	
Eq. 17.6.5.5.1c		Eq. 17.4.5.5c	
17.7.1.2		17.5.1.2	
Eq. 17.7.1.2(b)		Eq. 17.5.1.2b	
17.7.2		17.5.2	
17.7.2.2		17.5.2.2	
17.7.3		17.5.3	
17.8		17.6	
17.9.2		17.7.1 and 17.7.3	
17.9.3		17.7.4	
17.9.5		17.7.6	
17.10		17.2.3	
17.10.5.3(a)(vi),		17.2.3.4.3(a)vi	
20.2.2.4 and 20.2.2.5		20.2.2.4 and 20.2.2.5	
26.6.3.2 (b)		26.6.3.1 (b)	
26.7.2		17.8.1 and 17.8.2	
26.7.1(l) and 26.7.2(e)		17.8.2.2 or 17.8.2.3	
26.13.3.2(e)		17.8.2.4, 26.7.1(h) and 26.13.3.2(c)	

Pure50+ Instruction Card

**DESCRIPTION:** Pure50+ is a high strength, 100% solids epoxy adhesive which is formulated for use in a wide variety of applications. Refer to installation instructions and SDS for additional detailed information.

**PRECAUTION:** Safety glasses and dust masks should be used when drilling holes into concrete, stone and masonry. Wear gloves and safety glasses when handling and dispensing adhesive. Do not sand the adhesive and create silica dust which could be inhaled. Avoid skin and eye contact. Use a NIOSH-approved chemical respirator for respiratory protection. Wash hands or face after contact with adhesive. If adhesive gets into eyes, flush with plenty of water and seek immediate medical attention if eye contact occurs. Move to fresh air if adhesive odor begins to cause discomfort.

**IMPORTANT!** Before using, read and review Safety Data Sheet (SDS). This product contains crystalline silica (quartz sand) as a Group 1 carcinogen hazard. Avoid chronic exposure (via inhalation) to silica dust, e.g. mixing, quarry stone crushing, refractory brick and pottery workers. This product does not pose a dust hazard, therefore this classification is not relevant. However, if reacted (fully cured) product is further processed (e.g. sanded, drilled) be sure to wear proper respiratory and eye protection to avoid health risk.

**HANDLING AND STORAGE:** Store in a cool, well-ventilated area at temperatures between 41°F (5°C) and 86°F (30°C). Keep partially used containers closed when not in use. Protect from damage. Keep away from children and pets.

Keep application site or product label before use. Do not use expired product. Partially used cartridges may be stored with hardened adhesive in the attached mixing nozzle. Note: If the cartridge is reused, attach a new mixing nozzle and discard initial quantity of anchor adhesive as described in installation instructions.

DEWALT  
709 East Joppa Road  
Towson, MD 21286 U.S.A.  
P: (800) 542-3244

anchors@DEWALT.com  
www.DEWALT.com

[V] Pure50+ epoxy system selection table

Dispersers	Cartridges	Mixing nozzles
Tool	Size	Size
Manual	Heavy Duty [98438-FMR] (caulk-styrd)	9.5 fl.oz.
Manual	Caulk Gun [98438-FMR] (caulk-styrd)	9.5 fl.oz.
Manual	[98438-FMR]	[98294-FMR or 98604-FMR]
Compress	[98413-FMR] Dual tube	20.5 fl.oz.
Compress	[98510-1]	[98604-FMR or 98606-FMR]
Pneumatic	[98438-FMR] Dual tube	50.5 fl.oz.

[VI] Gel working times and curing times for adhesive

Temperature of base material	Gel working time	Full curing time
50°F	10 minutes	24 hours
60°F	20 minutes	8 hours
68°F	25 minutes	6 hours
75°F	30 minutes	6 hours
85°F	35 minutes	6 hours
95°F	40 minutes	4 hours
104°F	45 minutes	4 hours
110°F	45 minutes	4 hours

Linear interpolation for intermediate base material temperatures is possible.

[VII] Hole cleaning tools and accessories for Adhesive Anchors

Rod dia. (in.)	Rebar dia. (in.)	Fractional anchor sizes				Metric anchor sizes			
		Brush size (in.)	Brush length (in.)	Wire brush size (in.)	Piston plug size (in.)	Brush size (mm)	Brush length (mm)	Wire brush size (mm)	Piston plug size (mm)
3/8	3/8	5/16	6/16	6/16	0.25	12	12	12	12
1/2	1/2	9/16	6/16	0.25	N/A	14	14	170	DPC1670160
5/8	5/8	7/8	0.25	N/A	N/A	16	16	200	DPC1670200
3/4	3/4	7/8	0.25	N/A	N/A	18	18	200	DPC1670200
7/8	7/8	1 1/8	0.25	N/A	N/A	20	20	300	DPC1670300
1	1	1 1/8	0.25	N/A	N/A	25	25	300	DPC1670300
1 1/4	1 1/4	1 7/8	0.25	N/A	N/A	28	28	300	DPC1670300
1 1/2	1 1/2	2 1/8	0.25	N/A	N/A	32	32	300	DPC1670300
2	2	2 3/4	0.25	N/A	N/A	38	38	300	DPC1670300

Wire brush  
Brush extension  
SDS adaptor  
Compressed air nozzle  
Std. piston plug

Holes are drilled with hammer-drill (i.e. rotary impact drills or rock drills with a carbide drill bit), including the use of hollow drill bits). For any case, it must be possible for the anchor to be inserted into the cleaned drill hole without resistance.

A brush extension (Cat. #08292) must be used with a steel wire brush for holes drilled deeper than the listed brush length.

Brush adaptors for power tool connections are available for drill chuck (Cat. # 08291) and SDS (Cat. # 08293).

A brush extension (Cat. #08292) must be used with a steel wire brush for holes drilled deeper than the listed brush length.

All overhead (i.e. upward) inclined installations require the use of piston plugs where one is tabulated together with the anchor size and where the embedment depth is greater than 8 inches.

All horizontal installations require the use of piston plugs where one is tabulated together with the anchor size and where the embedment depth is greater than 8 inches.

A plastic extension tube (Cat. #08291 or 08297) or equivalent approved by DEWALT must be used with piston plugs.

[VIII] Installation parameters - Specifications for installation of threaded rods and reinforcing bars for Adhesive Anchors

Anchor property / Setting information	Nominal threaded rod / reinforcing bar size			
	#4	#5	#6	#7
d = Threaded rod outside diameter (in.)	0.375	0.500	0.625	0.750
d = Nominal rebar diameter (in.)	0.375	0.500	0.625	0.750
dia (d) = Nominal ANSI drill bit size (in.)	3/16	1/4	5/16	3/8
dia (d) = Minimum embedment (inches)	2 1/8	2 1/4	2 1/2	2 3/4
dia (d) = Maximum embedment (inches)	4 1/2	5 1/4	6 1/4	7 1/4
dia (d) = Minimum member thickness (inches)	1 1/2	1 3/4	2 1/4	3 1/4
dia (d) = Minimum spacing (inches)	1 1/2	1 3/4	2 1/4	3 1/4
dia (d) = Minimum edge distance (inches)	1 1/2	1 3/4	2 1/4	3 1/4
dia (d) = Maximum torque (ft.-lb.) for A307 Grade 36 and Grade 55	5	20	60	100
dia (d) = Maximum torque (ft.-lb.) for A307 Grade 36 and Grade 55	5	20	60	100
dia (d) = Minimum edge distance (reduced) (inches)	1 1/2	1 3/4	2 1/4	3 1/4
dia (d) = Maximum torque (ft.-lb.) reduced edges	7.5	14	27	47
dia (d) = Minimum edge distance (reduced) (inches)	1 1/2	1 3/4	2 1/4	3 1/4
dia (d) = Maximum torque (ft.-lb.) reduced edges	7.5	14	27	47

Notes: #4 = 1/2" diameter, #5 = 3/4" diameter, #6 = 1" diameter, #7 = 1 1/4" diameter.  $N_{ax} = 2d$ , where d is hole diameter.

Torque may not be applied to the anchors until the full cure time of the adhesive has been achieved.

† Cases 1) Stainless steel threaded rods of equivalent. Torque may not be applied to the anchors until the full cure time of the adhesive has been achieved.

‡ These torque values apply to ASTM A 193 Grade B888M (Class 1) stainless steel threaded rod only.

FIGURE 3—MANUFACTURER'S PRINTED INSTALLATION INSTRUCTIONS (MPII)



# Pure50+ Instruction Card (continued)



SELECT HAMMER DRILLING AS SUITABLE FOR APPLICATION	
<p><b>HAMMER DRILLING</b></p> 	<p><b>1</b> Drill a hole into the base material with rotary hammer drill (i.e. percussion drill) and a carbide drill bit to the size and embedment required by the selected steel hardware element (see Table III). Tolerances of carbide drill bits including hollow drill bits must meet ANSI Standard B212.15.</p> <p><b>Precaution:</b> Wear suitable eye and skin protection. Avoid inhalation of dusts during drilling and/or removal (see dust extraction equipment by DEWALT to minimize dust emissions).</p> <p><b>Notes:</b> In case of standing water in the drilled hole (flooded hole condition), all the water has to be removed from the hole (e.g. vacuum, compressed air, etc.) prior to cleaning.</p> <p>Drilling in dry concrete is recommended when using hollow drill bits (vacuum must be on).</p> <p>→ <b>Go to Step 3 for holes drilled with DustX+™ extraction system (no further hole cleaning is required). Otherwise go to Step 2a for hole cleaning instructions.</b></p>
<p><b>HOLE CLEANING DRY OR WET HOLES</b></p>  <p>Repeat Blowing 2x</p> <p>Brush 2x</p>	<p><b>2a</b> Starting from the bottom or back of the drilled anchor hole, blow the hole clean a minimum of two times (2x).</p> <p>Use a compressed air nozzle (min. 90 psi) for all sizes of anchor rod and reinforcing bar (rebar).</p> <p><b>2b</b> Determine wire brush diameter (see Table III) for the drilled hole and attach the brush with adaptor to a rotary drill tool or battery screw gun. Brush the hole with the selected wire brush a minimum of two times (2x).</p> <p>A brush extension (supplied by DEWALT) must be used for holes drilled deeper than the listed brush length. The wire brush diameter must be checked periodically during use; the brush should resist insertion into the drilled hole; if not the brush is too small and must be replaced with the proper brush diameter (i.e. new wire brush).</p> <p><b>2c</b> Repeat Step 2a again by blowing the hole clean a minimum of two times (2x).</p> <p>When finished the hole should be clean and free of dust, debris, oil or other foreign material.</p> <p>→ <b>Next go to Step 3.</b></p>
<p>This section is intentionally left blank.</p>	
FOLLOW STEPS #1 THROUGH #10 FOR RECOMMENDED INSTALLATION	
<p><b>PREPARING</b></p> 	<p><b>3</b> Check adhesive expiration date on cartridge label. Do not use expired product. Review Safety Data Sheet (SDS) before use. Cartridge adhesive temperature must be between 50°F - 110°F (10°C - 43°C) when in use. For overhead applications cartridge adhesive temperature must be between 50°F - 90°F (10°C - 32°C) when in use. For best adhesive dispensing experience, suggested minimum cartridge adhesive temperature is 65°F (20°C) when in use. Review published gel (working) and cure times. Consideration should be given to the reduced gel (working) time of the adhesive in warm temperatures. For the permitted range of the base material temperature see Table II.</p> <p>Attach a supplied mixing nozzle to the cartridge. Do not modify the mixer in any way and make sure the mixing element is inside the nozzle. Load the cartridge into the correct dispensing tool.</p> <p><b>Note:</b> Always use a new mixing nozzle with new cartridges of adhesive and also for all work interruptions exceeding the published gel (working) time of the adhesive.</p> <p><b>4</b> Prior to inserting an anchor rod or rebar into the drilled hole, the position of the embedment depth has to be marked on the anchor. Verify anchor element is straight and free of surface damage.</p> <p><b>5</b> Adhesive must be properly mixed to achieve published properties. Prior to dispensing adhesive into the drilled hole, separately dispense at least three full strokes of adhesive through the mixing nozzle until the adhesive is a consistent grey color.</p> <p>Review and note the published gel (working) and cure times prior to injection of the mixed adhesive into the cleaned anchor hole (see Table II).</p>
<p><b>INSTALLATION</b></p>  <p>with piston plug:</p>	<p><b>6</b> Fill the cleaned hole approximately two-thirds full with mixed adhesive starting from the bottom or back of the anchor hole. A plastic extension tube must be used with the mixing nozzle if the bottom or back of the anchor hole is not reached with the mixing nozzle only (see Table III). Slowly withdraw the mixing nozzle as the hole fills to avoid creating air pockets or voids.</p> <p><b>Note:</b> Piston plugs must be used with and attached to mixing nozzle and extension tube for overhead (i.e. upwardly inclined) installations and horizontal installations with anchor rod sizes as indicated in Table III. Insert piston plug to the back of the drilled hole and inject as described in the method above. During injection of the adhesive the piston plug will be naturally extruded from the drilled hole by the adhesive pressure.</p> <p><b>Attention!</b> Do not install anchors overhead without proper training, and installation hardware provided by DEWALT; contact DEWALT prior to use.</p> <p><b>7</b> The anchor should be free of dirt, grease, oil or other foreign material. Push clean threaded rod or reinforcing bar into the anchor hole while turning slightly to ensure positive distribution of the adhesive until the embedment depth is reached. Observe the gel (working) time.</p> <p><b>8</b> Ensure that the anchor element is installed to the specified embedment depth. Adhesive must completely fill the annular gap at the concrete surface. Following installation of the anchor element, remove excess adhesive. Protect the anchor element threads from fouling with adhesive.</p> <p>For all installations the anchor element must be restrained from movement throughout the specified curing period (where necessary) through the use of temporary wedges, external supports, or other methods. Minor adjustments to the position of the anchor element may be performed during the gel (working) time only.</p> <p><b>9</b> Allow the adhesive anchor to cure to the specified full curing time prior to applying any load (see Table IV).</p> <p><b>Note:</b> Do not disturb, torque or load the anchor until it is fully cured.</p>
<p><b>CURING &amp; FIXTURE</b></p> 	<p><b>10</b> After full curing of the adhesive anchor, a fixture can be installed to the anchor and tightened up to the maximum torque (shown in Table III) by using a calibrated torque wrench.</p> <p><b>Note:</b> Take care not to exceed the maximum torque for the selected anchor.</p>

FIGURE 3—MANUFACTURER’S PRINTED INSTALLATION INSTRUCTIONS (MPII) (Continued)



**DIVISION: 03 00 00—CONCRETE****Section: 03 16 00—Concrete Anchors****DIVISION: 05 00 00—METALS****Section: 05 05 19—Post-Installed Concrete Anchors****REPORT HOLDER:**

DEWALT

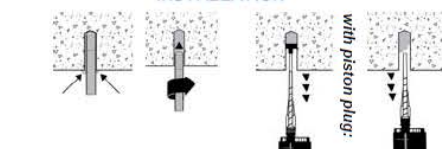
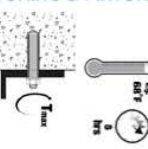
**EVALUATION SUBJECT:****PURE50+™ EPOXY ADHESIVE ANCHOR SYSTEM IN CRACKED AND UNCRACKED CONCRETE (DEWALT)****1.0 REPORT PURPOSE AND SCOPE****Purpose:**

The purpose of this evaluation report supplement is to indicate that the Pure50+ Epoxy Adhesive Anchor System in Cracked and Uncracked Concrete, described in ICC-ES evaluation report ESR-3576, has also been evaluated for compliance with the codes noted below.

**Applicable code editions:**

- 2023 *Florida Building Code—Building*
- 2023 *Florida Building Code—Residential*

**2.0 CONCLUSIONS**

The Pure50+ Epoxy Adhesive Anchor System in Cracked and Uncracked Concrete, described in Sections 2.0 through 7.0 of the evaluation report ESR-3576, complies with the *Florida Building Code—Building* and the *Florida Building Code—Residential*. The design requirements must be determined in accordance with the *Florida Building Code—Building* or the *Florida Building Code—Residential*, as applicable. The installation requirements noted in ICC-ES evaluation report ESR-3576 for the 2021 *International Building Code*® meet the requirements of the *Florida Building Code—Building* or the *Florida Building Code—Residential*, as applicable.

Use of the Pure50+ epoxy adhesive anchors has also been found to be in compliance with the High-Velocity Hurricane Zone provisions of the *Florida Building Code—Building* and the *Florida Building Code—Residential* with the following condition:

- a) For connections subject to uplift, the connection must be designed for no less than 700 pounds (3114 N).

For products falling under Florida Rule 61G20-3, verification that the report holder's quality assurance program is audited by a quality assurance entity approved by the Florida Building Commission for the type of inspections being conducted is the responsibility of an approved validation entity (or the code official, when the report holder does not possess an approval by the Commission).

This supplement expires concurrently with the evaluation report, reissued July 2024 and revised October 2024.