

ICC-ES Evaluation Report

ESR-4810

Reissued June 2024

Revised October 2024

Subject to renewal June 2025



This report also contains:

- [City of LA Supplement](#)

- [FL Supplement w/ HVHZ](#)

ICC-ES Evaluation Reports are not to be construed as representing aesthetics or any other attributes not specifically addressed, nor are they to be construed as an endorsement of the subject of the report or a recommendation for its use. There is no warranty by ICC Evaluation Service, LLC, express or implied, as to any finding or other matter in this report, or as to any product covered by the report.

Copyright © 2024 ICC Evaluation Service, LLC. All rights reserved.

<p>DIVISION: 03 00 00— CONCRETE</p> <p>Section: 03 16 00— Concrete Anchors</p> <p>DIVISION: 05 00 00— METALS</p> <p>Section: 05 05 19—Post- Installed Concrete Anchors</p>	<p>REPORT HOLDER:</p> <p>DEWALT</p> 	<p>EVALUATION SUBJECT:</p> <p>CCU+™ CARBON STEEL AND STAINLESS STEEL UNDERCUT ANCHORS IN CRACKED AND UNCRACKED CONCRETE (DEWALT)</p>	
--	---	--	---

1.0 EVALUATION SCOPE

Compliance with the following codes:

- 2024, 2021, 2018, and 2015 [International Building Code® \(IBC\)](#)
- 2024, 2021, 2018, and 2015 [International Residential Code® \(IRC\)](#)

Main references of this report are for the 2024 IBC and IRC. See [Table 6](#) and [Table 7](#) for applicable sections of the code for previous IBC and IRC editions.

Property evaluated:

- Structural

2.0 USES

The CCU+ Undercut Anchors are used as anchorage to resist static, wind, and seismic tension and shear loads in cracked and uncracked normal-weight and lightweight concrete having a specified compressive strength, f'_c , of 2,500 psi to 8,500 psi (17.2 MPa to 58.6 MPa). The anchors comply as anchors installed in hardened concrete as described in Section 1901.3 of the 2024 IBC. The anchors may also be used where an engineered design is submitted in accordance with Section R301.1.3 of the IRC.

3.0 DESCRIPTION

3.1 General:

The CCU+ Undercut Anchors are displacement controlled undercut anchors. The anchors are available in carbon steel or stainless steel materials and are comprised of the following components: an anchor rod (threaded rod), internally threaded expander cone, expansion sleeve, washer and hex nut as shown in [Figure 1](#). The anchors are installed into pre-drilled holes in concrete that have been undercut at the bottom, and after setting the expanded anchor sleeve creates a mechanical interlock with the surrounding concrete base material.

The CCU+ Undercut Anchors are available in preset and thubolt versions (designated as PS and TB, respectively). Sizes available include 3/8-inch (9.5 mm), 1/2-inch (12.7 mm), 5/8-inch (15.9 mm), and 3/4-inch (19.1 mm) diameters and various lengths. [Table 1](#) shows dimensions of the undercut anchors. A painted setting mark (used for visual setting control) is provided on the anchor rods of the anchor assemblies.

3.2 Anchor Materials:

3.2.1 Carbon Steel Anchors: The anchor rods (threaded rods) used are ASTM A36 strength carbon steel and ASTM A193 Grade B7 high strength carbon steel. The expander cone and expansion sleeve are manufactured from medium carbon steel complying with requirements set forth in the approved quality documentation. The carbon steel hex nuts comply with ASTM A563 Grade C, SAE J995 Grade 8 (for $3/8$ -inch size only) or equivalent. The carbon steel washers comply with ASTM F844 or equivalent. All carbon steel components have a minimum 0.0002-inch (5 μ m) zinc plating in accordance with ASTM B633.

3.2.2 Stainless Steel Anchors: The anchor rods (threaded rods) used are ASTM A193, Grade B8M Class 2 high strength stainless steel (316 SS). The expander cone and expansion sleeve are manufactured from AISI 316 stainless steel complying with requirements set forth in the approved quality documentation. The stainless steel hex nuts comply with ASTM A194 Grade 8M, ASTM F594 Group 2 (316 SS) (for $3/8$ -inch size only) or equivalent. The stainless steel washers comply with AISI 316 or equivalent.

3.3 Concrete:

Normal-weight and lightweight concrete must conform to Sections 1903 and 1905 of the 2024 IBC, as applicable.

4.0 DESIGN AND INSTALLATION

4.1 Strength Design:

4.1.1 Design strength of anchors complying with the 2024 IBC, as well as Section R301.1.3 of the 2024 must be determined in accordance with ACI 318-19 Chapter 17 and this report.

A design example according to ACI 318-19 is given in [Figure 4](#) of this report. Design parameters are described in [Tables 4](#) and [5](#) of this report and are based on the 2024 IBC (ACI 318-19), unless noted otherwise in Sections 4.1.1 through 4.1.12. The strength design of anchors must comply with ACI 318-19 Section 17.5.1.2, except as required in ACI 318-19 Section 17.10.

Strength reduction factors, ϕ , as given in ACI 318-19 Section 17.5.3 and [Table 4](#) must be used for load combinations calculated in accordance with Section 1605.1 of the 2024 IBC and Section 5.3 of ACI 318-19.

The value of f'_c used in the calculations must be limited to a maximum of 8,000 psi (55.2 MPa), in accordance with ACI 318-19 Section 17.3.1.

4.1.2 Requirements for Static Steel Strength in Tension, N_{sa} : The nominal steel strength of a single anchor in tension, N_{sa} , must be calculated in accordance with ACI 318-19 Section 17.6.1.2. The resulting values of N_{sa} are described in [Table 4](#) of this report. Strength reduction factors, ϕ , corresponding to ductile steel elements may be used.

4.1.3 Requirements for Static Concrete Breakout Strength in Tension, N_{cb} or N_{cbg} : The nominal concrete breakout strength of a single anchor or group of anchors in tension, N_{cb} and N_{cbg} , respectively, must be calculated in accordance with ACI 318-19 Section 17.6.2 and modifications as described in this section. The basic concrete breakout strength of a single anchor in tension in regions where analysis indicates cracking, N_b , must be calculated according to ACI 318-19 Section 17.6.2.2, using the values of h_{ef} and k_{cr} as described in [Table 4](#) of this report. Concrete breakout strength in tension in regions where analysis indicates no cracking in accordance with ACI 318-19 Section 17.6.2.5.1(a) must be calculated with $\Psi_{c,N} = 1.0$ and using the value of k_{uncr} as given in [Table 4](#) of this report.

4.1.4 Requirements for Static Pullout Strength in Tension, N_{pn} : In cracked and uncracked concrete, pullout strength does not control and therefore need not be evaluated.

4.1.5 Requirements for Static Steel Strength in Shear, V_{sa} : The nominal steel strength in shear, V_{sa} , of a single anchor in accordance with ACI 318-19 Section 17.7.1.2 is given in [Table 4](#) for the preset type and thurbolt type anchors and must be used in lieu of the values derived by calculation from ACI 318-19 Eq. 17.7.1.2b. Strength reduction factors, ϕ , corresponding to ductile steel elements must be used.

4.1.6 Requirements for Static Concrete Breakout Strength in Shear, V_{cb} or V_{cbg} : The nominal static concrete breakout strength of a single anchor or a group of anchors in shear, V_{cb} or V_{cbg} , respectively, must be calculated in accordance with ACI 318-19 Section 17.7.2, with modifications as described in this section. The basic concrete breakout strength of a single anchor in shear must be calculated in accordance with ACI 318-19 Section 17.7.2.2.1, where the value of l_e and d_a used in ACI 318-19 Eq. 17.7.2.2.1a must be taken as h_{ef} , but no greater than $8d_a$.

4.1.7 Requirements for Static Concrete Pryout Strength in Shear, V_{cp} or V_{cpg} : The nominal static concrete pryout strength of a single anchor or a group of anchors in shear, V_{cp} or V_{cpg} , respectively, must be calculated in accordance with ACI 318-19 Section 17.7.3, modified by using the value K_{cp} provided in [Table 4](#) and the value N_{cb} and N_{cbg} as calculated in Section 4.1.3 of this report.

4.1.8 Requirements for Seismic Design: General: For load combinations including seismic, the design must be performed in accordance with ACI 318-19 Section 17.10. Modifications to ACI 318-19 Section 17.10 must be applied under Section 1905.7 of the 2024 IBC.

The anchors comply with ACI 318-19 Section 2.3 as ductile steel elements and must be designed in accordance with ACI 318-19 Sections 17.10.4, 17.10.5, 17.10.6, and 17.10.7.

For determination of stretch lengths of CCU+ undercut anchors, see [Table 3A](#) of this report. The anchor rod, d_{rod} replaces the outside anchor diameter, d_a (i.e. expansion sleeve diameter, d_s) for stretch length and stretch length ratio. Stretch lengths of the anchor rod (threaded rod) in the anchor assemblies, for embedment's given in this report, are greater than eight anchor rod diameters, $8d_{rod}$ which meets the prescriptive requirements as given in ACI 318-19 Section 17.10.5.3(a).

The $3/8$ -inch-diameter (9.5 mm), $1/2$ -inch-diameter (12.7 mm), $5/8$ -inch-diameter (15.9 mm) and $3/4$ -inch-diameter (19.1 mm) CCU+ undercut anchors may be installed in structures assigned to Seismic Design Categories A through F.

4.1.8.1 Seismic Tension: The nominal steel strength and nominal concrete breakout strength for anchors in tension must be calculated in accordance with ACI 318-19 Sections 17.6.1 and 17.6.2, as described in Sections 4.1.2 and 4.1.3 of this report. In cracked and uncracked concrete, pullout strength in tension for seismic loads, $N_{p,eq}$, does not control and therefore need not be evaluated.

4.1.8.2 Seismic Shear: The nominal concrete breakout strength and pryout strength for anchors in shear must be calculated according to ACI 318-19 Section 17.7.2 and 17.7.3, as described in Sections 4.1.6 and 4.1.7 of this report. In accordance with ACI 318-19 Section 17.7.1.2, the appropriate value for nominal steel strength in shear for seismic loads $V_{sa,eq}$, described in [Table 4](#) must be used in lieu of V_{sa} .

4.1.9 Requirements for Interaction of Tensile and Shear Forces: The effects of combined tensile and shear forces must be determined in accordance with ACI 318-19 Section 17.8.

4.1.10 Requirements for Critical Edge Distance: In lieu of ACI 318-19 Section 17.6.2, the modification factor $\psi_{cp,N} = 1.0$ for all cases. In accordance with ACI 318-19 Section 17.9.5, tension tests in accordance with ACI 355.2 have determined splitting failure under external load does not govern the resistance of the CCU+, i.e. $c_{ac} = 1.5h_{ef}$. Therefore, this calculation is not required for design. For reference values of c_{ac} , critical edge distance determined by $c_{ac} = 1.5h_{ef}$ are provided in [Table 4](#) of this report.

4.1.11 Requirements for Minimum Member Thickness, Minimum Anchor Spacing and Minimum Edge Distance: In lieu of ACI 318-19 Section 17.9.2, values of s_{min} and c_{min} provided in [Table 3A](#) of this report must be used. In lieu of ACI 318-19 Section 17.9.4, minimum member thickness, h_{min} , must be in accordance with [Table 3A](#) of this report.

4.1.12 Lightweight Concrete: For the use of anchors in lightweight concrete, the modification factor λ_a equal to 1.0λ is applied to all values of $\sqrt{f'_c}$ affecting N_n and V_n .

The value of λ must be determined in accordance with the corresponding version of ACI 318.

4.2 Allowable Stress Design:

4.2.1 General: For anchors designed using load combinations in accordance with Section 1605.1 of the 2024 IBC, allowable loads must be established using the equations below:

$$T_{allowable,ASD} = \frac{\phi N_n}{\alpha} \quad (\text{Eq-3})$$

$$V_{allowable,ASD} = \frac{\phi V_n}{\alpha} \quad (\text{Eq-4})$$

where:

$T_{allowable,ASD}$ = Allowable tension load (lb or N).

$V_{allowable,ASD}$ = Allowable shear load (lb or N).

- ϕN_n = Lowest design strength of an anchor or anchor group in tension as determined in accordance with ACI 318-19 Chapter 17, 2024 IBC Section 1905.7, and Section 4.1 of this report, as applicable (lb or N).
- ϕV_n = Lowest design strength of an anchor or anchor group in shear as determined in accordance with ACI 318-19 Chapter 17, 2024 IBC Section 1905.7, and Section 4.1 of this report, as applicable (lb or N).
- α = Conversion factor calculated as a weighted average of the load factors for the controlling load combination. In addition, α must include all applicable factors to account for non-ductile failure modes and required over-strength.

Limits on edge distance, anchor spacing, and member thickness as given in [Table 3A](#) of this report must apply. An example of Allowable Stress Design tension values is given in [Table 5](#).

4.2.2 Interaction of Tensile and Shear Forces: The interaction must be calculated and consistent with ACI 318-19 Section 17.8, as follows:

For shear loads $V \leq 0.2 V_{allowable, ASD}$, the full allowable load in tension must be permitted.

For tension loads $T \leq 0.2 T_{allowable, ASD}$, the full allowable load in shear must be permitted.

For all other cases:

$$\frac{T}{T_{allowable}} + \frac{V}{V_{allowable}} \leq 1.2 \quad (\text{Eq-5})$$

4.3 Installation:

Installation parameters are described in [Tables 1, 3A, and 3B](#) and [Figures 1 through 3](#) of this report. Anchor locations must comply with the plans and specifications approved by the code official and this report. Anchors must be installed in accordance with the manufacturer's printed installation instructions (MPII) and this report. Holes must be drilled normal to the concrete surface using carbide-tipped masonry drill bits complying with ANSI B212.15-1994. Undercut drill bits, stop drill bits, and setting sleeves must be supplied by DEWALT.

4.4 Special Inspection:

Periodic special inspection is required, in accordance with Section 1705.1.1 and Table 1705.3 of the 2024 IBC. The special inspector must make periodic inspections during anchor installation to verify anchor type, anchor dimensions, concrete type, concrete compressive strength, hole dimensions, hole cleaning procedure, anchor spacing, edge distances, concrete thickness, anchor embedment, tightening torque and adherence to the manufacturer's printed installation instructions. The special inspector must be present as often as required in accordance with the "Statement of Special Inspection." Under the IBC, additional requirements as set forth in Chapter 17 must be observed, where applicable.

5.0 CONDITIONS OF USE:

The CCU+™ Undercut Anchors described in this report comply with, or are suitable alternatives to what is specified in, those codes listed in Section 1.0 of this report, subject to the following conditions:

- 5.1 Anchor sizes, dimensions, and minimum embedment depths are as set forth in the tables of this report.
- 5.2 The anchors must be installed in accordance with the manufacturer's published installation instructions and this report. In cases of a conflict, this report governs.
- 5.3 Anchors must be limited to use in concrete with a specified strength, f'_c , from 2,500 to 8,500 psi (17.2 to 58.6 MPa).
- 5.4 The values of f'_c used for calculation purposes must not exceed 8,000 psi (55.1 MPa).
- 5.5 Strength design values must be established in accordance with Section 4.1 of this report.
- 5.6 Allowable stress design values must be established in accordance with Section 4.2 of this report.
- 5.7 Anchor spacing and edge distance, as well as minimum member thickness, must comply with [Table 4](#) of this report.
- 5.8 Prior to installation, calculations and details demonstrating compliance with this report must be submitted to the code official for approval. The calculations and details must be prepared by a registered design professional where required by the statutes of the jurisdiction in which the project is to be constructed.

- 5.9 Since an ICC-ES acceptance criteria for evaluating data to determine the performance of undercut anchors subjected to fatigue or shock loading is unavailable at this time, the use of these anchors under these conditions is beyond the scope of the report.
- 5.10 Anchors may be installed in regions of concrete where cracking has occurred or where analysis indicates cracking may occur ($f_t > f_r$), subject to the conditions of this report.
- 5.11 Anchors may be used to resist short-term loading due to wind or seismic forces, subject to the conditions of this report.
- 5.12 Where not otherwise prohibited in the code, anchors are permitted for installation in fire-resistance rated construction provided that at least one of the following conditions is fulfilled:
- Anchors are used to resist wind or seismic forces only.
 - Anchors that support a fire-resistance-rated envelope or a fire-resistance-rated membrane are protected by approved fire-resistance-rated materials, or have been evaluated for resistance to fire exposure in accordance with recognized standards.
 - Anchors are used to support nonstructural elements.
- 5.13 Use of zinc-coated carbon steel anchors must be limited to dry, interior locations.
- 5.14 Use of anchors made of stainless steel as specified in this report are permitted for exterior exposure or damp environments.
- 5.15 Use of anchors made of stainless steel as specified in this report are permitted for contact with preservative-treated and fire-retardant-treated wood.
- 5.16 Special inspection must be provided in accordance with Section 4.4.
- 5.17 Anchors are manufactured under an approved quality control program with inspections by ICC-ES.











6.0 EVIDENCE SUBMITTED

Data in accordance with the [ICC-ES Acceptance Criteria for Mechanical Anchors in Concrete Elements \(AC193\)](#), dated July 2024, which incorporates requirements in ACI 355.2 (-19 and -07) for use in cracked and uncracked concrete; including optional suitability tests for seismic tension and shear; and quality control documentation.

7.0 IDENTIFICATION

- 7.1 The anchors are identified by a length letter code head marking stamped on the exposed end of the rod, and packaging labeled with the company name and address, anchor name (CCU+), anchor size, and evaluation report number (ESR-4810).
- 7.2 The report holder's contact information is the following:

DEWALT
701 EAST JOPPA ROAD
TOWSON, MARYLAND 21286
(800) 524-3244
www.DEWALT.com
anchors@DEWALT.com

DeWALT Dust Removal Drilling System with HEPA Dust Extractor Options		
Tool	Accessories and Shrouds	Dust Extractor
SDS-Max Drills		
 <p>Cordless</p>	 <p>SDS-Max Hollow Drill Bits</p>	 <p>Dust Extractor</p>
 <p>Corded</p>	 <p>SDS-Max Drill Bits With Shroud</p>	
SDS-Plus Drills		
 <p>Cordless</p>	 <p>SDS-Plus Hollow Drill Bits</p>	 <p>Dust Extractor</p>
 <p>Corded</p>	 <p>SDS-Plus Drill Bits With Telescope</p>	
	 <p>SDS-Plus Drill Bits With Shroud</p>	

The DEWALT drilling systems shown collect and remove dust with a HEPA dust extractor during the hole drilling operation in dry base materials using a rotary hammer-drill (see the manufacturer's printed installation instructions).

FIGURE A—EXAMPLES OF DEWALT DUST REMOVAL DRILLING SYSTEMS WITH HEPA DUST EXTRACTORS FOR ILLUSTRATION

TABLE 1—CCU+ UNDERCUT ANCHOR NOMINAL DIMENSIONAL CHARACTERISTICS^{1,2,3}

Anchor Description, Nominal Size and Length (in.)	Anchor Rod Designation (ASTM)	Anchor Version	Rod Diameter, d_{rod} (in.)	Anchor Length, l_b (in.)	Expansion Sleeve		Expander Cone Dia., d_c (in.)	Max. Fixture Thickness, t_{max} (in.)
					Length, l_s (in.)	Diameter, d_s (in.)		
$\frac{3}{8} \times 6$	A36 or A193, Grade B7	Preset (PS)	$\frac{3}{8}$	6	4	$\frac{11}{16}$	$\frac{11}{16}$	$\frac{7}{8}$
		Thrubolt (TB)			$4\frac{7}{8}$			
	A193, Grade B8M (316 SS)	Preset (PS)	$\frac{3}{8}$	6	4	$\frac{11}{16}$	$\frac{11}{16}$	
		Thrubolt (TB)			$4\frac{7}{8}$			
$\frac{1}{2} \times 7\frac{1}{2}$	A36 or A193, Grade B7	Preset (PS)	$\frac{1}{2}$	$7\frac{1}{2}$	5	$\frac{13}{16}$	$\frac{13}{16}$	$1\frac{1}{4}$
		Thrubolt (TB)			$6\frac{1}{4}$			
	A193, Grade B8M (316 SS)	Preset (PS)	$\frac{1}{2}$	$7\frac{1}{2}$	5	$\frac{13}{16}$	$\frac{13}{16}$	
		Thrubolt (TB)			$6\frac{1}{4}$			
$\frac{1}{2} \times 8\frac{1}{4}$	A36 or A193, Grade B7	Preset (PS)	$\frac{1}{2}$	$8\frac{1}{4}$	5	$\frac{13}{16}$	$\frac{13}{16}$	2
		Thrubolt (TB)			7			
	A193, Grade B8M (316 SS)	Preset (PS)	$\frac{1}{2}$	$8\frac{1}{4}$	5	$\frac{13}{16}$	$\frac{13}{16}$	
		Thrubolt (TB)			7			
$\frac{5}{8} \times 10\frac{3}{4}$	A36 or A193, Grade B7	Preset (PS)	$\frac{5}{8}$	$10\frac{3}{4}$	$7\frac{1}{2}$	1	1	$1\frac{5}{8}$
		Thrubolt (TB)			$9\frac{1}{8}$			
	A193, Grade B8M (316 SS)	Preset (PS)	$\frac{5}{8}$	$10\frac{3}{4}$	$7\frac{1}{2}$	1	1	
		Thrubolt (TB)			$9\frac{1}{8}$			
$\frac{5}{8} \times 11\frac{1}{2}$	A36 or A193, Grade B7	Preset (PS)	$\frac{5}{8}$	$11\frac{1}{2}$	$7\frac{1}{2}$	1	1	$2\frac{3}{8}$
		Thrubolt (TB)			$9\frac{7}{8}$			
	A193, Grade B8M (316 SS)	Preset (PS)	$\frac{5}{8}$	$11\frac{1}{2}$	$7\frac{1}{2}$	1	1	
		Thrubolt (TB)			$9\frac{7}{8}$			
$\frac{3}{4} \times 14$	A36 or A193, Grade B7	Preset (PS)	$\frac{3}{4}$	14	10	$1\frac{1}{4}$	$1\frac{1}{4}$	2
		Thrubolt (TB)			12			
	A193, Grade B8M (316 SS)	Preset (PS)	$\frac{3}{4}$	14	10	$1\frac{1}{4}$	$1\frac{1}{4}$	
		Thrubolt (TB)			12			
$\frac{3}{4} \times 16$	A36 or A193, Grade B7	Preset (PS)	$\frac{3}{4}$	16	10	$1\frac{1}{4}$	$1\frac{1}{4}$	4
		Thrubolt (TB)			14			
	A193, Grade B8M (316 SS)	Preset (PS)	$\frac{3}{4}$	16	10	$1\frac{1}{4}$	$1\frac{1}{4}$	
		Thrubolt (TB)			14			

For SI: 1 inch = 25.4 mm.

¹Preset anchors are designed so the top of the expansion sleeve is approximately flush with the base material after setting.

Thrubolt anchors are designed so the expansion sleeve can be set through and can engage the fixture. See Figure 2 and Table 3A of this report.

²Anchor rod (threaded rod) conforming to ASTM F1554, Grade 105 is strength equivalent to the tabulated ASTM A193, Grade B7 designation.

³The listed anchor lengths are based on the anchor sizes commercially available at the time of publication; custom lengths can be produced by request. Custom length anchors not long enough to meet the minimum embedment requirements of this report are outside the scope of this report.

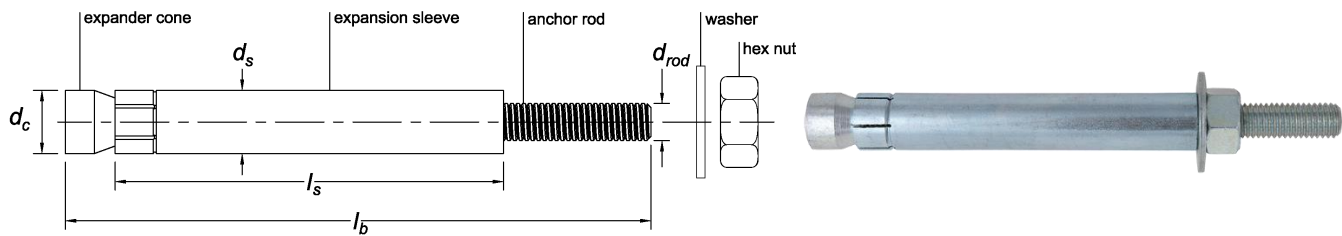

FIGURE 1—CCU+ UNDERCUT ANCHOR ASSEMBLY

TABLE 2—ANCHOR LENGTH CODE IDENTIFICATION SYSTEM

Length ID marking on anchor rod head		A	B	C	D	E	F	G	H	I	J	K	L	M	N	O	P	Q	R	S	T	U	V	W	X
Anchor length, l_b , (inches)	From	$1\frac{1}{2}$	2	$2\frac{1}{2}$	3	$3\frac{1}{2}$	4	$4\frac{1}{2}$	5	$5\frac{1}{2}$	6	$6\frac{1}{2}$	7	$7\frac{1}{2}$	8	$8\frac{1}{2}$	9	$9\frac{1}{2}$	10	11	12	13	14	15	16
	Up to but not including	2	$2\frac{1}{2}$	3	$3\frac{1}{2}$	4	$4\frac{1}{2}$	5	$5\frac{1}{2}$	6	$6\frac{1}{2}$	7	$7\frac{1}{2}$	8	$8\frac{1}{2}$	9	$9\frac{1}{2}$	10	11	12	13	14	15	16	17

For SI: 1 inch = 25.4 mm.

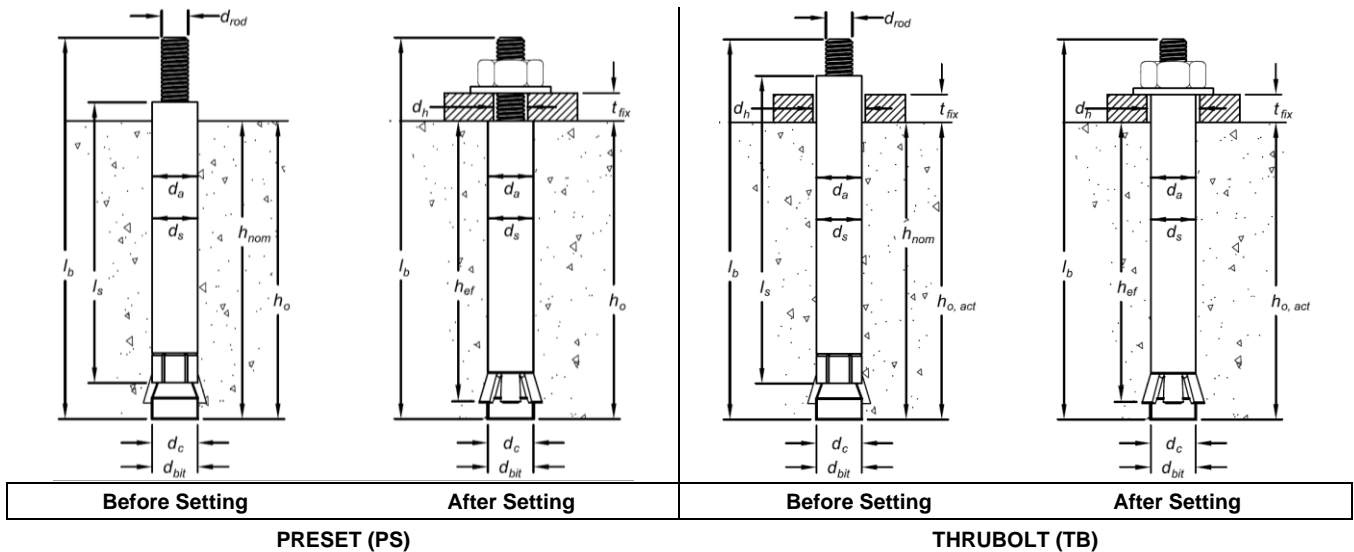

FIGURE 2—CCU+ UNDERCUT ANCHOR DETAIL

TABLE 3A—CCU+ UNDERCUT ANCHOR INSTALLATION SPECIFICATIONS AND SUPPLEMENTAL INFORMATION

Anchor Property / Setting Information	Notation	Units	Nominal Anchor Size / Rod Diameter, d_{rod} (in.)											
			$3/8$			$1/2$			$5/8$			$3/4$		
Anchor rod designation	ASTM	-	A36	A193, Gr. B7	A193, Gr. B8M (316 SS)	A36	A193, Gr. B7	A193, Gr. B8M (316 SS)	A36	A193, Gr. B7	A193, Gr. B8M (316 SS)	A36	A193, Gr. B7	A193, Gr. B8M (316 SS)
Outside anchor diameter / expansion sleeve diameter	d_a / d_s	in. (mm)	0.6875 (17.5)			0.8125 (20.6)			1.00 (25.4)			1.25 (31.8)		
Nominal drill bit diameter (ANSI)	d_{bit}	in. (mm)	$1^{1/16}$			$1^{3/16}$			1			$1^{1/4}$		
Nominal embedment depth ¹	h_{nom}	in. (mm)	$4^{1/4}$ (108)			$5^{3/8}$ (137)			8 (203)			$10^{5/8}$ (270)		
Effective embedment depth	h_{ef}	in. (mm)	4 (102)			5 (127)			$7^{1/2}$ (191)			10 (254)		
Minimum hole depth, preset version (see note 2 for thrubolt version)	h_o	in. (mm)	$4^{1/4}$ (108)			$5^{3/8}$ (137)			8 (203)			$10^{5/8}$ (270)		
Min. concrete thickness, preset version (see note 3 for thrubolt version)	h_{min}	in. (mm)	6 (152)			7 (178)			$9^{1/2}$ (241)			12 (305)		
Minimum edge distance	c_{min}	in. (mm)	$2^{1/2}$ (64)			3 (76)			$4^{1/2}$ (114)			6 (152)		
Minimum spacing distance	s_{min}	in. (mm)	3 (76)			$3^{3/4}$ (95)			$5^{3/8}$ (143)			$7^{1/2}$ (191)		
Minimum diameter of clearance hole in fixture	Preset (PS)	in. (mm)	$7/16$ (11.1)			$9/16$ (14.3)			$1^{1/16}$ (17.5)			$1^{3/16}$ (20.6)		
	Thrubolt (TB)		$3/4$ (19.1)			$7/8$ (22.2)			$1^{3/8}$ (28.6)			$1^{3/8}$ (34.9)		
Maximum thickness of fixture	t_{max}	in.	See Table 1			See Table 1			See Table 1			See Table 1		
Installation torque	T_{inst}	ft.-lbf. (N-m)	11 (15)	37 (50)		29 (40)	70 (95)		70 (95)	118 (160)		118 (160)	221 (300)	
Torque wrench / socket size ⁷	-	in.	$9/16$			$7/8$			$1^{1/16}$			$1^{1/4}$		
Nut height ⁷	-	in.	$2^{1/64}$			$3^{1/64}$			$3^{9/64}$			$4^{7/64}$		
Effective tensile stress area (anchor rod)	A_{se}	in. ² (mm ²)	0.078 (50)			0.142 (91)			0.226 (146)			0.334 (245)		
Minimum specified ultimate strength ⁴	f_{uta}	psi (N/mm ²)	58,000 (400)	125,000 (860)	120,000 (827)	58,000 (400)	125,000 (860)	110,000 (758)	58,000 (400)	125,000 (860)	110,000 (758)	58,000 (400)	125,000 (860)	110,000 (758)
Minimum specified yield strength	f_{ya}	psi (N/mm ²)	36,000 (248)	105,000 (723)	95,000 (655)	36,000 (248)	105,000 (723)	95,000 (655)	36,000 (248)	105,000 (723)	95,000 (655)	36,000 (248)	105,000 (723)	95,000 (655)
Stretch length of the anchor rod ⁵	-	in.	$h_{nom} - 1^{1/16} + t_{fix}$			$h_{nom} - 1^{3/16} + t_{fix}$			$h_{nom} - 1 + t_{fix}$			$h_{nom} - 1^{1/4} + t_{fix}$		
Mean axial stiffness ⁶	Uncracked concrete	β_{uncr}	595,000			1,705,000			356,000			446,000		
	Cracked concrete	β_{cr}	398,000			744,000			445,000			354,000		

For SI: 1 inch = 25.4 mm, 1 ft-lbf = 1.356 N-m.

¹The embedment depth, h_{nom} , is measured from the outside surface of the concrete member to the embedded end of the anchor and equal to the hole depth.

²For thrubolt applications the actual hole depth, $h_{o,act}$ is dependent on the actual fixture thickness, t_{fix} and determined by taking the minimum hole depth plus the maximum thickness of fixture for the selected anchor less the thickness of the actual part(s) being fastened to the base material ($h_{o,act} = h_o + t_{max} - t_{fix}$).

³For thrubolt applications the minimum concrete member thickness, $h_{min,act}$ is dependent on the actual fixture thickness, t_{fix} and determined by taking the minimum concrete member thickness plus the maximum thickness of fixture for the selected anchor less the thickness of the actual part(s) being fastened to the base material ($h_{min,act} = h_{min} + t_{max} - t_{fix}$).

⁴The anchor rod for the $3/8$ -inch stainless steel anchors is manufactured with a minimum specified ultimate strength of 120 ksi (827 N/mm²).

⁵For CCU+ undercut anchors, the anchor rod, d_{rod} replaces the outside anchor diameter, d_a (i.e. the expansion sleeve diameter, d_s) for determination of stretch length and stretch length ratio; see Section 4.1.8 of this report.

⁶Mean values shown, actual stiffness varies considerably depending on concrete strength, loading and geometry of application.

⁷Nut dimensions shown correlate to heavy hex nuts except for $3/8$ -inch-diameter anchors which have dimensions that correlate to hex nuts at the time of publication.

TABLE 3B—CCU+ UNDERCUT ANCHOR INSTALLATION ACCESSORIES AND TOOLS^{1,2}

Nominal Anchor Size	Nominal Hole Diameter	Anchor Version	Primary Drill Bits			Undercut Drill Bits		Rotary Hammer Drill	Setting Sleeves	
			Hollow Stop Bit	Hollow Bit	Conventional Bit	Hollow Undercut Bit	Undercut Bit		Powered	Manual
3/8"	11/16"	Preset (PS)	DFX11380 (SDS-Plus)	DWA54116 (SDS-Plus)	DW5808 4-Cutter (SDS-Max)	DFX21380 (SDS-Plus)	DFX21381 (SDS-Plus)	DCH416 or D25416 (SDS-Plus)	DFX313825 (SDS-Plus)	DFX313805
		Thrubolt (TB)	-							
1/2"	13/16"	Preset (PS)	DFX11120 (SDS-Plus)	DWA54316 (SDS-Plus)	DW5814 4-Cutter (SDS-Max)	DFX21120 (SDS-Plus)	DFX21121 (SDS-Plus)	DCH416 or D25416 (SDS-Plus)	DFX311230 (SDS-Plus)	DFX311210
		Thrubolt (TB)	-							
5/8"	1"	Preset (PS)	DFX11580 (SDS-Max)	DWA58001 (SDS-Max)	DW5852 4-Cutter (SDS-Max)	DFX21580* (SDS-Plus)	DFX21581* (SDS-Plus)	DCH614 or D25614 (SDS-Max)	DFX315835 (SDS-Max)	DFX315815
		Thrubolt (TB)	-							
3/4"	1-1/4"	Preset (PS)	DFX11340 (SDS-Max)	DWA58114 (SDS-Max)	DW5855 4-Cutter (SDS-Max)	DFX21340 (SDS-Max)	DFX21341 (SDS-Max)	DCH614 or D25614 (SDS-Max)	DFX313440 (SDS-Max)	DFX313420
		Thrubolt (TB)	-							

*For rotary hammer drill connector options, designated drill bits can be considered for use with a DW5891 SDS-Max to SDS-Plus adapter.

¹The listed anchor installation accessories and tools are based on DEWALT equipment commercially available at the time of publication.

²CCU+ dust removal drill bits (e.g. HSB, HB, HUCB) are used with a vacuum dust extractor (e.g. DWV010, DWV012, DWV015, DCV585).

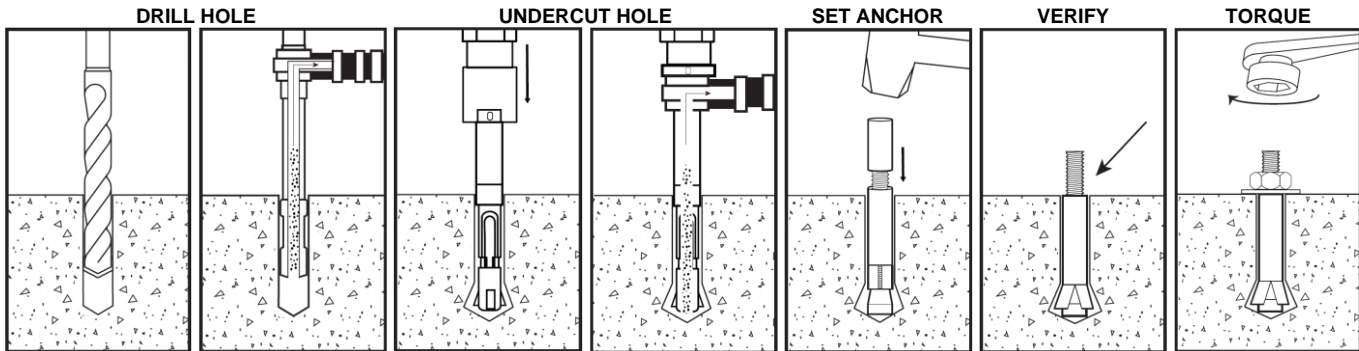
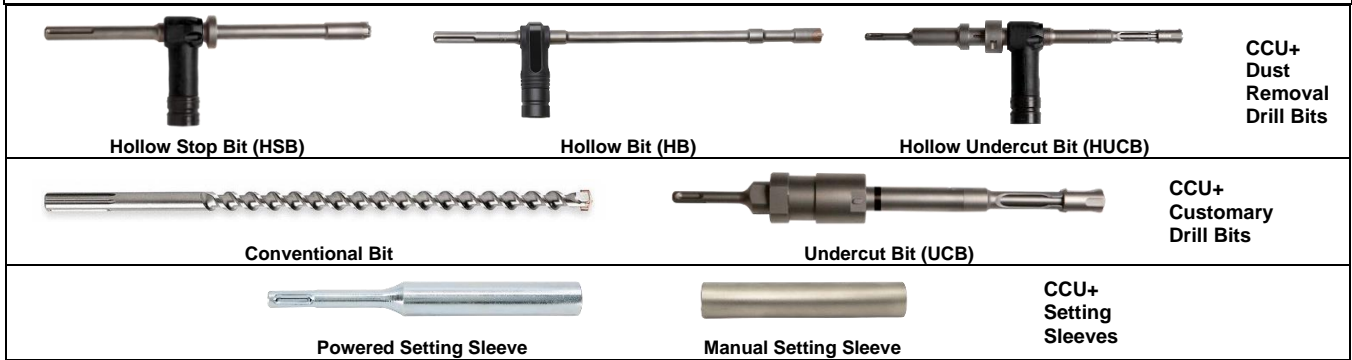

- Using the proper drill bit size, drill a hole into the base material to the required depth. The tolerances of the drill bit used should meet the requirements of ANSI Standard B212.15.
- Remove dust and debris from the hole during drilling (e.g. hollow stop bit, hollow bit, dust extractor) or following drilling (e.g. suction, forced air) to extract loose particles created by drilling. Note: removing dust and debris after drilling is not required for overhead (ceiling) installations.
- Insert the proper size undercut bit to the bottom of the hole. Start the rotary hammer (begin at a slow speed) and undercut the hole. Undercutting is complete when the stopper sleeve on the undercut bit is fully compressed (i.e. the gap is closed).
- Remove dust and debris from the hole during undercutting (hollow undercut bit) or following undercutting (e.g. suction, forced air). Note: removing dust and debris after drilling is not required for overhead (ceiling) installations.
- Insert anchor into the hole. Place setting sleeve over anchor rod and drive expansion sleeve over expander cone. Use the proper size powered setting sleeve or manual setting sleeve.
- Verify that the setting mark is visible on the anchor rod (threaded rod) at or above the expansion sleeve.
- Apply the proper installation torque to tighten the connection.

FIGURE 3—CCU+ UNDERCUT ANCHOR INSTALLATION INSTRUCTIONS

TABLE 4—DESIGN INFORMATION FOR CARBON STEEL AND STAINLESS STEEL CCU+ UNDERCUT ANCHORS^{1,2,8}

Anchor Property / Setting Information	Notation	Units	Nominal Anchor Size / Rod Diameter, d_{rod} (in.)												
			$\frac{3}{8}$			$\frac{1}{2}$			$\frac{5}{8}$			$\frac{3}{4}$			
Anchor category	-	-	1												
Anchor rod designation	ASTM	-	A36	A193, Gr. B7	A193, Gr.B8M (316SS)	A36	A193, Gr. B7	A193, Gr.B8M (316SS)	A36	A193, Gr. B7	A193, Gr.B8M (316SS)	A36	A193, Gr. B7	A193, Gr.B8M (316SS)	
Outside diameter of anchor	d_a	in. (mm)	0.6875 (17.5)			0.8125 (20.6)			1.00 (25.4)			1.25 (31.8)			
Nominal embedment depth	h_{nom}	in. (mm)	4 ^{1/4} (108)			5 ^{3/8} (137)			8 (203)			10 ^{5/8} (270)			
Effective embedment depth	h_{ef}	in. (mm)	4 (102)			5 (127)			7 ^{1/2} (190)			10 (254)			
STEEL STRENGTH IN TENSION (ACI 318-19 Section 17.6.1), STEEL STRENGTH IN SHEAR (ACI 318-19 Section 17.7.1), AND STEEL STRENGTH IN SHEAR FOR SEISMIC APPLICATIONS (ACI 318-19 Section 17.10.3)															
Steel strength in tension, static/seismic	N_{sa}	lb. (kN)	4,525 (20.1)	9,750 (43.4)	9,360 (41.6)	8,235 (36.6)	17,750 (79.0)	15,620 (69.5)	13,110 (58.3)	28,250 (125.7)	24,860 (110.6)	19,370 (86.2)	41,750 (185.7)	36,740 (163.4)	
Reduction factor, steel strength in tension ^{3,4}	ϕ	-	0.75												
Preset (PS)	Steel strength in shear, static	V_{sa}	lb. (kN)	2,260 (10.1)	4,875 (21.7)	5,110 (22.7)	4,120 (18.3)	8,875 (39.5)	8,850 (39.4)	6,555 (29.1)	14,125 (62.8)	14,600 (64.9)	9,685 (43.1)	20,875 (92.9)	22,340 (99.4)
	Steel strength in shear, seismic	$V_{sa,eq}$	lb. (kN)	1,585 (7.0)	4,390 (19.5)	4,600 (20.5)	2,885 (12.8)	7,990 (35.5)	8,145 (36.2)	4,590 (20.4)	12,715 (56.6)	13,140 (58.5)	6,780 (30.2)	18,790 (83.6)	20,105 (89.4)
Thrubolt (TB)	Steel strength in shear, static	V_{sa}	lb. (kN)	2,260 (10.1)	14,200 (63.2)	15,555 (79.2)	4,120 (18.3)	18,715 (83.3)	24,205 (107.7)	6,555 (29.1)	28,980 (128.9)	38,795 (172.6)	9,685 (43.1)	41,640 (185.2)	57,725 (256.9)
	Steel strength in shear, seismic	$V_{sa,eq}$	lb. (kN)	1,585 (7.0)	12,790 (56.9)	10,895 (48.5)	2,885 (12.8)	16,840 (74.9)	19,365 (86.1)	4,590 (20.4)	26,080 (116.0)	31,345 (139.4)	6,780 (30.2)	33,315 (148.2)	46,180 (205.4)
Reduction factor, steel strength in shear ^{3,4}	ϕ	-	0.65												
CONCRETE BREAKOUT STRENGTH IN TENSION (ACI 318-19 Section 17.6.2)															
Critical edge distance (uncracked concrete) ⁷	c_{ac}	in. (mm)	6 (152)			7 ^{1/2} (191)			11 ^{1/4} (241)			15 (305)			
Effectiveness factor, uncracked concrete	k_{uncr}	-	30			30			30			30			
Effectiveness factor, cracked concrete	k_{cr}	-	24			24			24			24			
Modification factor for cracked and uncracked concrete ⁵	$\psi_{c,N}$	-	1.0 (see note 5)			1.0 (see note 5)			1.0 (see note 5)			1.0 (see note 5)			
Reduction factor, concrete breakout strength in tension ⁴	ϕ	-	0.65 (Condition B, no supplementary reinforcement) or 0.75 (Condition A, supplementary reinforcement present)												
PULLOUT STRENGTH IN TENSION (ACI 318-19 Section 17.6.3) AND PULLOUT STRENGTH IN TENSION FOR SEISMIC APPLICATIONS (ACI 318-19 Section 17.10.3)															
Characteristic pullout strength, uncracked concrete (2,500 psi)	$N_{p,uncr}$	lb. (kN)	See note 6			See note 6			See note 6			See note 6			
Characteristic pullout strength, cracked concrete (2,500 psi)	$N_{p,cr}$	lb. (kN)	See note 6			See note 6			See note 6			See note 6			
Characteristic pullout strength, seismic (2,500 psi)	$N_{p,eq}$	lb. (kN)	See note 6			See note 6			See note 6			See note 6			
Reduction factor, pullout strength in tension ⁴	ϕ	-	0.65 (Condition B)												
CONCRETE BREAKOUT STRENGTH IN SHEAR (ACI 318-19 Section 17.7.2) AND PRYOUT STRENGTH IN SHEAR (ACI 318-19 Section 17.7.3)															
Load bearing length of anchor	ℓ_e	in. (mm)	4 (102)			5 (127)			7 ^{1/2} (190)			10 (254)			
Coefficient for pryout strength	k_{cp}	-	2.0			2.0			2.0			2.0			
Reduction factor, concrete breakout strength in shear ⁴	ϕ	-	0.70 (Condition B, no supplementary reinforcement) or 0.75 (Condition A, supplementary reinforcement present)												
Reduction factor, pryout strength in shear ⁴	ϕ	-	0.70 (Condition B)												

For SI: 1 inch = 25.4 mm, 1 ksi = 6.895 MPa (N/mm²), 1 lbf = 0.0044 kN, 1 in² = 645 mm².

¹The data in this table is intended to be used with the design provisions of ACI 318-19 Chapter 17; for anchors resisting seismic load combinations the additional requirements of ACI 318-19 Section 17.10 must apply.

²Installation must comply with manufacturer's printed installation instructions and details.

³The anchors are considered ductile steel elements as defined by ACI 318-19 Section 2.3. See Section 4.1.8 and Table 3A of this report for the determination of stretch length, as applicable.

⁴The strength reduction factor applies when the load combinations from the 2024 IBC or ACI 318-19 are used and the requirements of ACI 318-19 Section 17.5.3 are met. For installations where supplementary reinforcement is present, the strength reduction factors described in ACI 318-19 Section 17.5.3 may be used for Condition A.

⁵Select the appropriate effectiveness factor for cracked concrete (k_{cr}) or uncracked concrete (k_{uncr}) and use $\psi_{c,N} = 1.0$.

⁶Pullout strength does not control design of indicated anchors and does not need to be calculated for indicated anchor size and embedment.

⁷See Section 4.1.10 of this report concerning the requirements for critical edge distance, c_{ac} , as applicable.

⁸Anchors are permitted to be used in lightweight concrete in accordance with Section 4.1.12 of this report.

TABLE 5—EXAMPLE ALLOWABLE STRESS DESIGN VALUES FOR ILLUSTRATIVE PURPOSES^{1,2,3,4,5,6,7,8,9}

Nominal Anchor Size (in.)	Nominal Embedment Depth (in.)	Effective Embedment (in.)	Anchor Rod Designation (ASTM)	Allowable Tension Load (pounds)
3/8	4 1/4	4	A36	2,295
			A193, Grade B7	4,940
			A193, Grade B8M (316 SS)	4,745
1/2	5 3/8	5	A36	4,175
			A193, Grade B7	7,365
			A193, Grade B8M (316 SS)	7,365
5/8	8	7 1/2	A36	6,645
			A193, Grade B7	13,530
			A193, Grade B8M (316 SS)	12,600
3/4	10 5/8	10	A36	9,815
			A193, Grade B7	20,830
			A193, Grade B8M (316 SS)	18,620

For SI: 1 inch = 25.4 mm, 1 lbf = 0.0044 kN.

Illustrative Allowable Stress Design Values in Table 5 are applicable only when the following design assumptions are followed:

- ¹ Single anchor with static tension load only.
- ² Concrete determined to remain uncracked for the life of the anchorage.
- ³ Load combinations from ACI 318-19 Section 5.3 (no seismic loading considered).
- ⁴ 30% dead load and 70% live load, controlling load combination 1.2D + 1.6L.
- ⁵ Calculation of weighted average for $\alpha = 1.2(0.3) + 1.6(0.7) = 1.48$.
- ⁶ $f'_c = 2,500$ psi (normal weight concrete).
- ⁷ $C_{a1} = C_{a2} \geq C_{ac}$.
- ⁸ $h \geq h_{min}$.
- ⁹ Values are for Condition B where supplementary reinforcement in accordance with ACI 318-19 Section 17.5.3 is not provided.

Calculation in accordance with ACI 318-19 Chapter 17 and this report:	ACI 318-19 Code Ref.	Report Ref.
<p>Step 1. Calculate steel strength of a single anchor in tension:</p> $\phi N_{sa} = (0.75)(9,360) = 7,020 \text{ lbs.}$	17.6.1.2	Table 4 §4.1.2
<p>Step 2. Calculate concrete breakout strength of a single anchor in tension:</p> $\phi N_{cb} = \phi \frac{A_{Nc}}{A_{Nco}} \psi_{ed,N} \psi_{c,N} \psi_{cp,N} N_b$ $N_b = k_c \lambda_a \sqrt{f'_c} (h_{ef})^{1.5}$ $N_b = (30)(1.0)\sqrt{2,500}(4.0)^{1.5} = 12,000 \text{ lbs.}$ $\phi N_{cb} = (0.65) \frac{(144.0)}{(144.0)} (1.0)(1.0)(1.0)(12,000) = 7,800 \text{ lbs.}$	17.6.2.1	Table 4 §4.1.3
<p>Step 3. Calculate pullout strength of a single anchor:</p> $\phi N_{pn} = \phi N_{p,uncr} \psi_{c,p} \left(\frac{f'_{c,act}}{2,500} \right)^{0.5}$ <p>$\phi N_{pn} = \text{N/A}$, per report pullout strength does not control</p>	17.6.3.2.1	Table 4 §4.1.4
<p>Step 4. Determine controlling factored resistance strength in tension:</p> $\phi N_n = \min[\phi N_{sa}, \phi N_{cb}, \phi N_{pn}] = \phi N_{sa} = 7,020 \text{ lbs.}$	17.5.1.3	-
<p>Step 5. Calculate allowable stress design conversion factor for loading condition:</p> <p>Controlling load combination: 1.2D + 1.6L</p> $\alpha = 1.2(30\%) + 1.6(70\%) = 1.48$	5.3	-
<p>Step 6. Calculate the converted allowable stress design value:</p> $T_{allowable,ASD} = \frac{\phi N_n}{\alpha} = \frac{7,020}{1.48} = 4,743 \text{ lbs.}$	-	§4.2

FIGURE 4—EXAMPLE STRENGTH DESIGN CALCULATION INCLUDING ASD CONVERSION FOR ILLUSTRATIVE PURPOSES

TABLE 6— APPLICABLE SECTIONS OF THE IBC UNDER EACH EDITION OF THE IBC

2024 IBC	2021 IBC	2018 IBC	2015 IBC
Section 1605.1		Section 1605.2 or 1605.3	
Section 1705.1.1 and Table 1705.3			
Section 1901.3			
Sections 1903 and 1905			
Section 1905.7	Section 1905.1.8		

TABLE 7— APPLICABLE SECTIONS OF ACI 318 UNDER EACH EDITION OF THE IBC

2024 IBC	2021 IBC	2018 IBC	2015 IBC
ACI 318-19		ACI 318-14	
2.3			2.3
5.3			5.3
Chapter 17		Chapter 17	
17.3.1			17.2.7
17.5.1.2			17.3.1
17.5.1.3			17.3.1.1
17.5.3			17.3.3
17.6.1			17.4.1
17.6.1.2			17.4.1.2
17.6.2			17.4.2
17.6.2.1			17.4.2.1
17.6.2.2			17.4.2.2
17.6.2.5.1(a)			17.4.2.6
17.6.3			17.4.3
17.6.3.2.1			17.4.3.2
17.7.1			17.5.1
17.7.1.2			17.5.1.2
Eq. 17.7.1.2b			Eq. 17.5.1.2b
17.7.2			17.5.2
17.7.2.2.1			17.5.2.2
Eq. 17.7.2.2.1			Eq. 17.5.2.2a
17.7.3			17.5.3
17.8			17.6
17.9.2			17.7.1 and 17.7.3
17.9.4			17.7.5
17.9.5			17.7.6
17.10			17.2.3
17.10.3			17.2.3.3
17.10.4, 17.10.5, 17.10.6, 17.10.7			17.2.3.4, 17.2.3.5, 17.2.3.6, 17.2.3.7
17.10.5.3(a)			17.2.3.4.3(a)

DIVISION: 03 00 00—CONCRETE
Section: 03 16 00—Concrete Anchors

DIVISION: 05 00 00—METALS
Section: 05 05 19—Post-Installed Concrete Anchors

REPORT HOLDER:

DEWALT

EVALUATION SUBJECT:

CCU+™ CARBON STEEL AND STAINLESS STEEL UNDERCUT ANCHORS IN CRACKED AND UNCRACKED CONCRETE (DEWALT)

1.0 REPORT PURPOSE AND SCOPE

Purpose:

The purpose of this evaluation report supplement is to indicate that the DEWALT CCU+ Carbon Steel and Stainless Steel Undercut Anchors in cracked and uncracked concrete, described in ICC-ES evaluation report [ESR-4810](#), have also been evaluated for compliance with the codes noted below as adopted by the Los Angeles Department of Building and Safety (LADBS).

Applicable code editions:

- 2023 *City of Los Angeles Building Code* ([LABC](#))
- 2023 *City of Los Angeles Residential Code* ([LARC](#))

2.0 CONCLUSIONS

The DEWALT CCU+ Carbon Steel and Stainless Steel Undercut Anchors in cracked and uncracked concrete, described in Sections 2.0 through 7.0 of the evaluation report [ESR-4810](#), comply with LABC Chapter 19, and the LARC, and are subjected to the conditions of use described in this supplement.

3.0 CONDITIONS OF USE

The CCU+ Undercut Anchors described in this evaluation report supplement must comply with all of the following conditions:

- All applicable sections in the evaluation report [ESR-4810](#).
- The design, installation, conditions of use and identification of the anchors are in accordance with the 2021 *International Building Code*® (2021 IBC) provisions noted in the evaluation report [ESR-4810](#).
- The design, installation and inspection are in accordance with additional requirements of LABC Chapters 16 and 17, as applicable.
- Under the LARC, an engineered design in accordance with LARC Section R301.1.3 must be submitted.
- The allowable and design strength values listed in the evaluation report and tables are for the connection of the anchors to the concrete. The connection between the anchors and the connected members shall be checked for capacity (which may govern).
- For use in wall anchorage assemblies to flexible diaphragm applications, anchors shall be designed per the requirements of City of Los Angeles Information Bulletin P/BC 2023-071.

This supplement expires concurrently with the evaluation report, reissued June 2024 and revised October 2024.

DIVISION: 03 00 00—CONCRETE

Section: 03 16 00—Concrete Anchors

DIVISION: 05 00 00—METALS

Section: 05 05 19—Post-Installed Concrete Anchors

REPORT HOLDER:

DEWALT

EVALUATION SUBJECT:**CCU+™ CARBON STEEL AND STAINLESS STEEL UNDERCUT ANCHORS IN CRACKED AND UNCRACKED CONCRETE (DEWALT)****1.0 REPORT PURPOSE AND SCOPE****Purpose:**

The purpose of this evaluation report supplement is to indicate that the DEWALT CCU+ Carbon Steel and Stainless Steel Undercut Anchors, described in ICC-ES evaluation report ESR-4810, have also been evaluated for compliance with the codes noted below.

Applicable code editions:

- 2023 Florida Building Code—Building
- 2023 Florida Building Code—Residential

2.0 CONCLUSIONS

The DEWALT CCU+ Undercut Anchors, described in Sections 2.0 through 7.0 of ICC-ES evaluation report ESR-4810, comply with the *Florida Building Code—Building* or the *Florida Building Code—Residential*. The design requirements must be determined in accordance with the *Florida Building Code—Building* or the *Florida Building Code—Residential*, as applicable. The installation requirements noted in ICC-ES evaluation report ESR-4810 for the 2021 *International Building Code*® meet the requirements of the *Florida Building Code—Building* or the *Florida Building Code—Residential*, as applicable.

Use of the DEWALT CCU+ Undercut Anchors has also been found to be in compliance with the High-Velocity Hurricane Zone provisions of the *Florida Building Code—Building* or the *Florida Building Code—Residential* with the following conditions:

- a) For anchorage to wood members, the connection subject to uplift must be designed for no less than 700 pounds (3114 N).
- b) For connection to aluminum members, all undercut anchors must be installed no less than 3 inches from the edge of concrete slab and/or footings. All undercut anchors shall develop an ultimate withdrawal resisting force equal to four times the imposed load, with no stress increase for duration of load.

For products falling under Florida Rule 61G20-3, verification that the report holder's quality assurance program is audited by a quality assurance entity approved by the Florida Building Commission for the type of inspections being conducted is the responsibility of an approved validation entity (or the code official when the report holder does not possess an approval by the Commission).

This supplement expires concurrently with the evaluation report, reissued June 2024 and revised October 2024.